

# STARPOWER

SEMICONDUCTOR

**IGBT**

## GD150FFA120C6S

**1200V/150A 6 in one-package**

### General Description

STARPOWER IGBT Power Module provides ultra low conduction loss as well as short circuit ruggedness. They are designed for the applications such as general inverters and UPS.

### Features

- Low  $V_{CE(sat)}$  Trench IGBT technology
- Short circuit capability
- $V_{CE(sat)}$  with positive temperature coefficient
- Maximum junction temperature 175°C
- Low inductance case
- Fast & soft reverse recovery anti-parallel FWD
- Isolated copper baseplate using DBC technology
- UL file number:E340089

### Typical Applications

- Inverter for motor drive
- AC and DC servo drive amplifier
- Uninterruptible power supply

### Equivalent Circuit Schematic

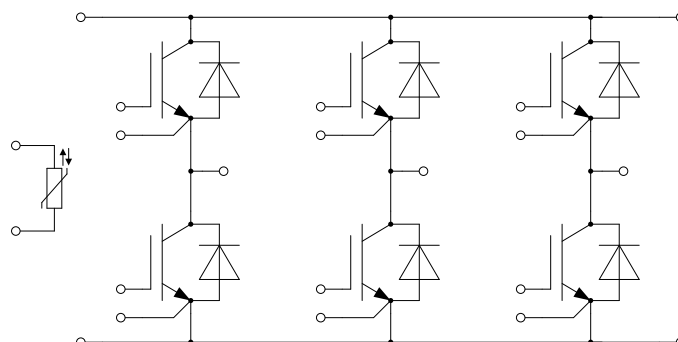

**Absolute Maximum Ratings**  $T_C=25^{\circ}\text{C}$  unless otherwise noted**IGBT**

Symbol	Description	Value	Unit
$V_{CES}$	Collector-Emitter Voltage	1200	V
$V_{GES}$	Gate-Emitter Voltage	$\pm 20$	V
$I_C$	Collector Current @ $T_C=85^{\circ}\text{C}$	150	A
$I_{CRM}$	Repetitive Peak Collector Current $t_p=1\text{ms}$	300	A

**Diode**

Symbol	Description	Value	Unit
$V_{RRM}$	Repetitive Peak Reverse Voltage	1200	V
$I_F$	Diode Continuous Forward Current	150	A
$I_{FRM}$	Repetitive Peak Forward Current $t_p=1\text{ms}$	300	A
$I_{FSM}$	Surge Forward Current $t_p=10\text{ms}$ @ $T_{vj}=125^{\circ}\text{C}$ @ $T_{vj}=150^{\circ}\text{C}$	575	A
		542	
$I^2t$	$I^2t$ -value, $t_p=10\text{ms}$ @ $T_{vj}=125^{\circ}\text{C}$ @ $T_{vj}=150^{\circ}\text{C}$	1653	$\text{A}^2\text{s}$
		1469	

**Module**

Symbol	Description	Value	Unit
$T_{vjmax}$	Maximum Junction Temperature	175	$^{\circ}\text{C}$
$T_{vjop}$	Operating Junction Temperature	-40 to +175	$^{\circ}\text{C}$
$T_{STG}$	Storage Temperature Range	-40 to +125	$^{\circ}\text{C}$
$V_{ISO}$	Isolation Voltage RMS, $f=50\text{Hz}$ , $t=1\text{min}$	2500	V
$d_{Creep}$	Terminal to Heatsink	10.0	mm
$d_{Clear}$	Terminal to Heatsink	7.5	mm
CTI	Comperative Tracking Index	$\geq 200$	
RTI	RTI Elec. Housing	140	$^{\circ}\text{C}$
Internal Isolation	Basic Insulation (class 1, IEC 61140)	$\text{Al}_2\text{O}_3$	

Note:  $T_{vjop} > 150^{\circ}\text{C}$  is allowed for operation at overload conditions.

**IGBT Characteristics**  $T_C=25^\circ\text{C}$  unless otherwise noted

Symbol	Parameter	Test Conditions	Min.	Typ.	Max.	Unit	
$V_{CE(sat)}$	Collector to Emitter Saturation Voltage	$I_C=150\text{A}, V_{GE}=15\text{V}, T_{vj}=25^\circ\text{C}$		1.50	1.95	V	
		$I_C=150\text{A}, V_{GE}=15\text{V}, T_{vj}=125^\circ\text{C}$		1.70			
		$I_C=150\text{A}, V_{GE}=15\text{V}, T_{vj}=150^\circ\text{C}$		1.80			
$V_{GE(th)}$	Gate-Emitter Threshold Voltage	$I_C=3.0\text{mA}, V_{CE}=V_{GE}, T_{vj}=25^\circ\text{C}$	5.4	6.2	7.0	V	
$I_{CES}$	Collector Cut-Off Current	$V_{CE}=V_{CES}, V_{GE}=0\text{V}, T_{vj}=25^\circ\text{C}$			50	$\mu\text{A}$	
$I_{GES}$	Gate-Emitter Leakage Current	$V_{GE}=V_{GES}, V_{CE}=0\text{V}, T_{vj}=25^\circ\text{C}$			100	nA	
$R_{Gint}$	Internal Gate Resistance			1.0		$\Omega$	
$C_{ies}$	Input Capacitance	$V_{CE}=25\text{V}, f=1\text{MHz}, V_{GE}=0\text{V}$		13.3		nF	
$C_{res}$	Reverse Transfer Capacitance				0.12		nF
$Q_G$	Gate Charge	$V_{GE}=-15\dots+15\text{V}$		0.96		$\mu\text{C}$	
$t_{d(on)}$	Turn-On Delay Time	$V_{CC}=600\text{V}, I_C=150\text{A}, R_G=3.9\Omega, L_S=35\text{nH}, V_{GE}=\pm 15\text{V}, T_{vj}=25^\circ\text{C}$		70		ns	
$t_r$	Rise Time			29		ns	
$t_{d(off)}$	Turn-Off Delay Time			246		ns	
$t_f$	Fall Time			175		ns	
$E_{on}$	Turn-On Switching Loss			11.8		mJ	
$E_{off}$	Turn-Off Switching Loss			10.9		mJ	
$t_{d(on)}$	Turn-On Delay Time		$V_{CC}=600\text{V}, I_C=150\text{A}, R_G=3.9\Omega, L_S=35\text{nH}, V_{GE}=\pm 15\text{V}, T_{vj}=125^\circ\text{C}$		80		ns
$t_r$	Rise Time				36		ns
$t_{d(off)}$	Turn-Off Delay Time			297		ns	
$t_f$	Fall Time			285		ns	
$E_{on}$	Turn-On Switching Loss			16.0		mJ	
$E_{off}$	Turn-Off Switching Loss			15.3		mJ	
$t_{d(on)}$	Turn-On Delay Time	$V_{CC}=600\text{V}, I_C=150\text{A}, R_G=3.9\Omega, L_S=35\text{nH}, V_{GE}=\pm 15\text{V}, T_{vj}=150^\circ\text{C}$			83		ns
$t_r$	Rise Time				38		ns
$t_{d(off)}$	Turn-Off Delay Time			306		ns	
$t_f$	Fall Time			315		ns	
$E_{on}$	Turn-On Switching Loss			17.2		mJ	
$E_{off}$	Turn-Off Switching Loss			16.2		mJ	
$I_{SC}$	SC Data		$t_p \leq 8\mu\text{s}, V_{GE}=15\text{V}, T_{vj}=150^\circ\text{C}, V_{CC}=600\text{V}, V_{CEM} \leq 1200\text{V}$		450		A

**Diode Characteristics**  $T_C=25^\circ\text{C}$  unless otherwise noted

Symbol	Parameter	Test Conditions	Min.	Typ.	Max.	Unit
$V_F$	Diode Forward Voltage	$I_F=150\text{A}, V_{GE}=0\text{V}, T_{vj}=25^\circ\text{C}$		1.60	2.05	V
		$I_F=150\text{A}, V_{GE}=0\text{V}, T_{vj}=125^\circ\text{C}$		1.65		
		$I_F=150\text{A}, V_{GE}=0\text{V}, T_{vj}=150^\circ\text{C}$		1.65		
$Q_r$	Recovered Charge			14.9		$\mu\text{C}$
$I_{RM}$	Peak Reverse Recovery Current	$V_R=600\text{V}, I_F=150\text{A},$ $-di/dt=4519\text{A}/\mu\text{s}, L_S=35\text{nH},$ $V_{GE}=-15\text{V}, T_{vj}=25^\circ\text{C}$		133		A
$E_{rec}$	Reverse Recovery Energy			4.97		mJ
$Q_r$	Recovered Charge			24.6		$\mu\text{C}$
$I_{RM}$	Peak Reverse Recovery Current	$V_R=600\text{V}, I_F=150\text{A},$ $-di/dt=3578\text{A}/\mu\text{s}, L_S=35\text{nH},$ $V_{GE}=-15\text{V}, T_{vj}=125^\circ\text{C}$		135		A
$E_{rec}$	Reverse Recovery Energy			8.76		mJ
$Q_r$	Recovered Charge			27.1		$\mu\text{C}$
$I_{RM}$	Peak Reverse Recovery Current	$V_R=600\text{V}, I_F=150\text{A},$ $-di/dt=3365\text{A}/\mu\text{s}, L_S=35\text{nH},$ $V_{GE}=-15\text{V}, T_{vj}=150^\circ\text{C}$		136		A
$E_{rec}$	Reverse Recovery Energy			9.67		mJ

**NTC Characteristics**  $T_C=25^\circ\text{C}$  unless otherwise noted

Symbol	Parameter	Test Conditions	Min.	Typ.	Max.	Unit
$R_{25}$	Rated Resistance			5.0		k $\Omega$
$\Delta R/R$	Deviation of $R_{100}$	$T_C=100^\circ\text{C}, R_{100}=493.3\Omega$	-5		5	%
$P_{25}$	Power Dissipation				20.0	mW
$B_{25/50}$	B-value	$R_2=R_{25}\exp[B_{25/50}(1/T_2-1/(298.15\text{K}))]$		3375		K
$B_{25/80}$	B-value	$R_2=R_{25}\exp[B_{25/80}(1/T_2-1/(298.15\text{K}))]$		3411		K
$B_{25/100}$	B-value	$R_2=R_{25}\exp[B_{25/100}(1/T_2-1/(298.15\text{K}))]$		3433		K

**Module Characteristics**  $T_C=25^\circ\text{C}$  unless otherwise noted

Symbol	Parameter	Min.	Typ.	Max.	Unit
$L_{CE}$	Stray Inductance		21		nH
$R_{CC'+EE'}$	Module Lead Resistance, Terminal to Chip		1.80		m $\Omega$
$R_{thJC}$	Junction-to-Case (per IGBT)			0.293	K/W
	Junction-to-Case (per Diode)			0.465	
$R_{thCH}$	Case-to-Heatsink (per IGBT)		0.128		K/W
	Case-to-Heatsink (per Diode)		0.143		
$M$	Mounting Torque, Screw:M5	3.0		6.0	N.m
$G$	Weight of Module		300		g

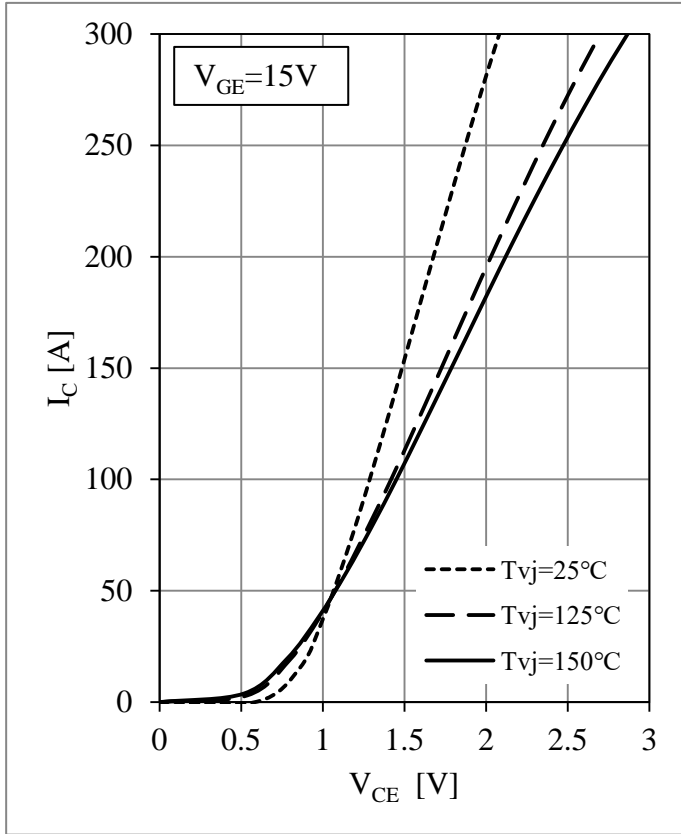

Fig 1. IGBT Output Characteristics

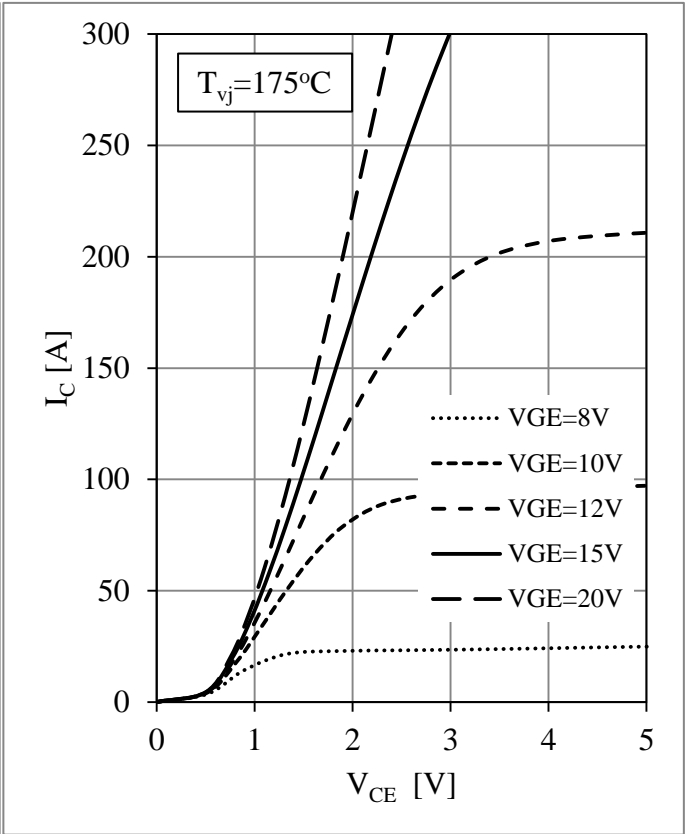

Fig 2. IGBT Output Characteristics

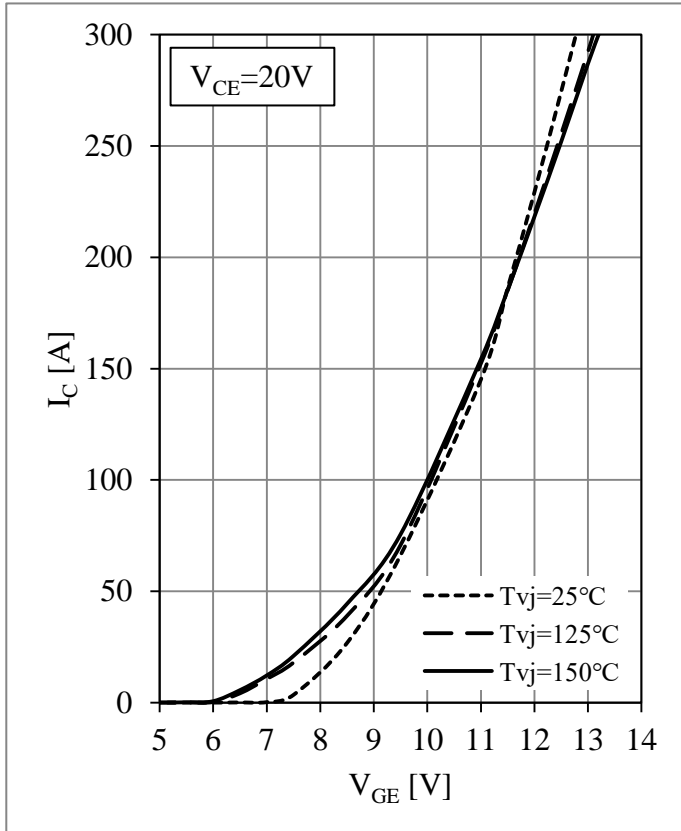

Fig 3. IGBT Transfer Characteristics

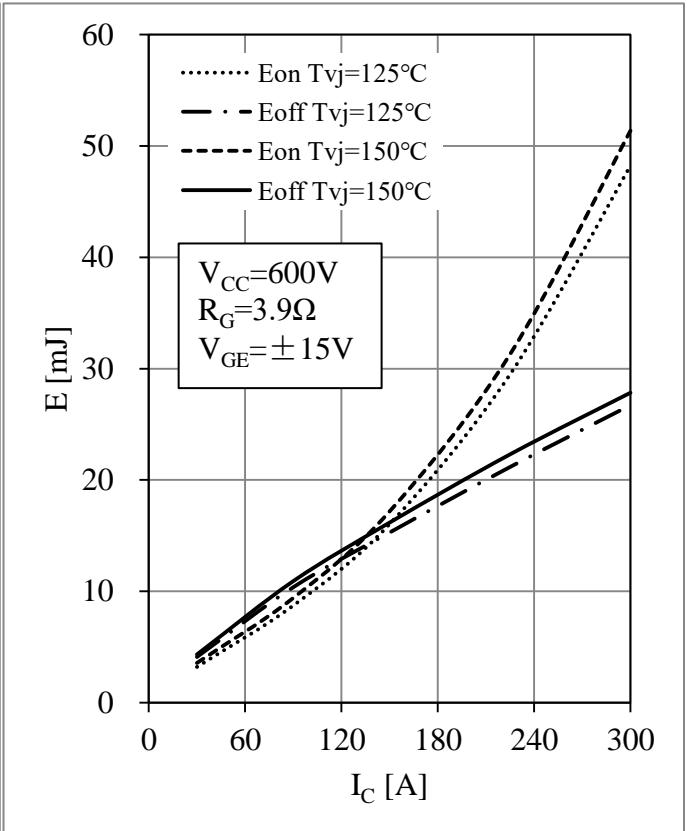

Fig 4. IGBT Switching Loss vs.  $I_C$

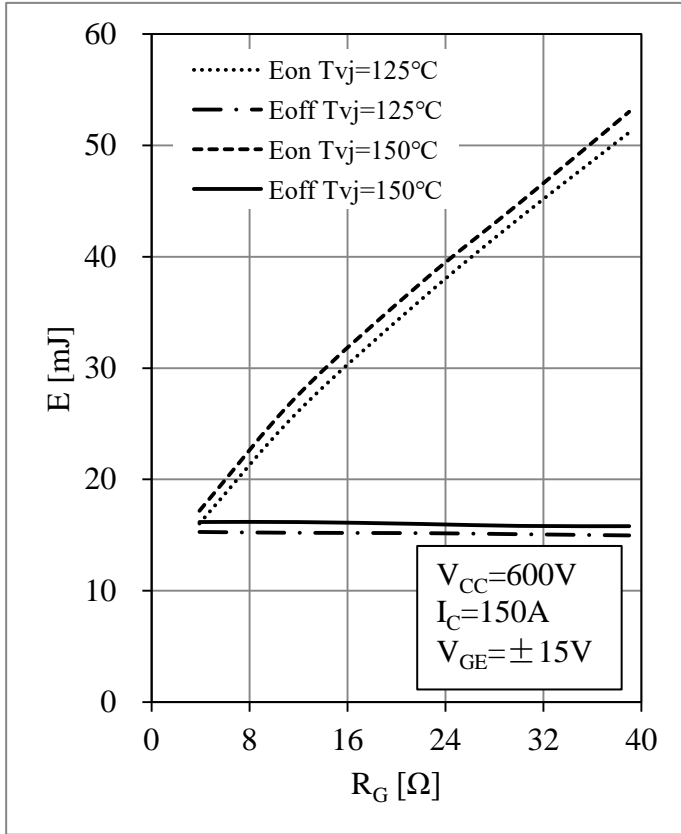

Fig 5. IGBT Switching Loss vs.  $R_G$

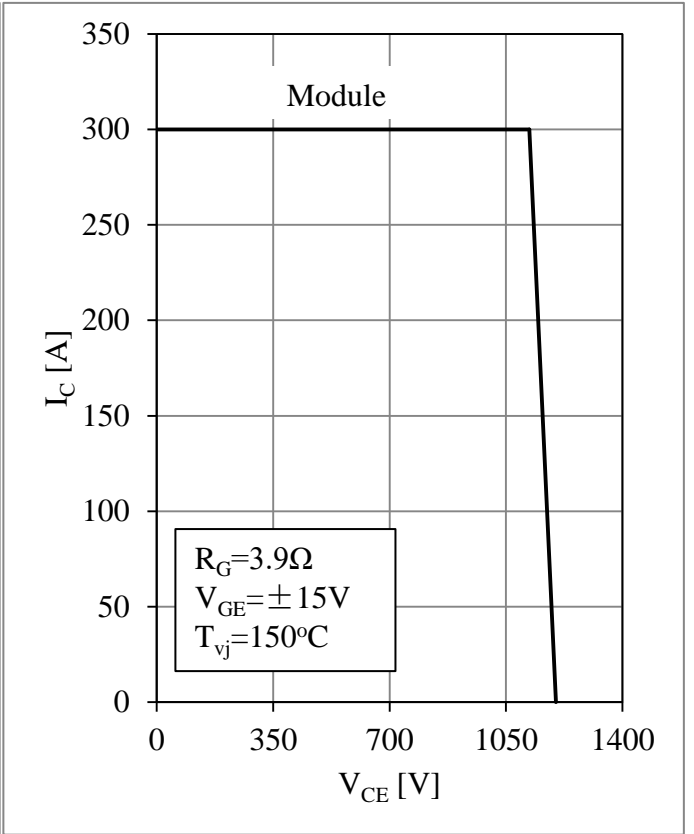

Fig 6. IGBT RBSOA

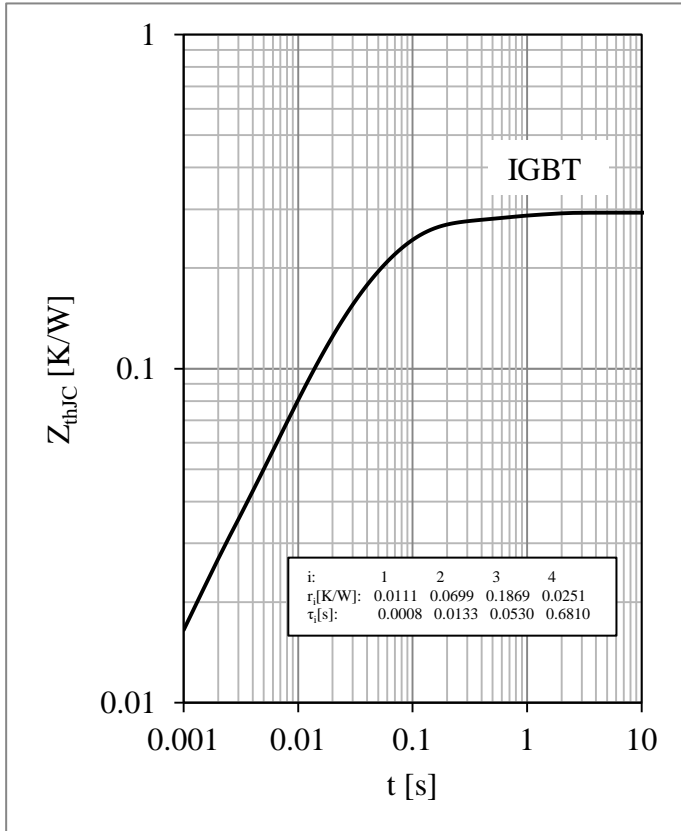

Fig 7. IGBT Transient Thermal Impedance

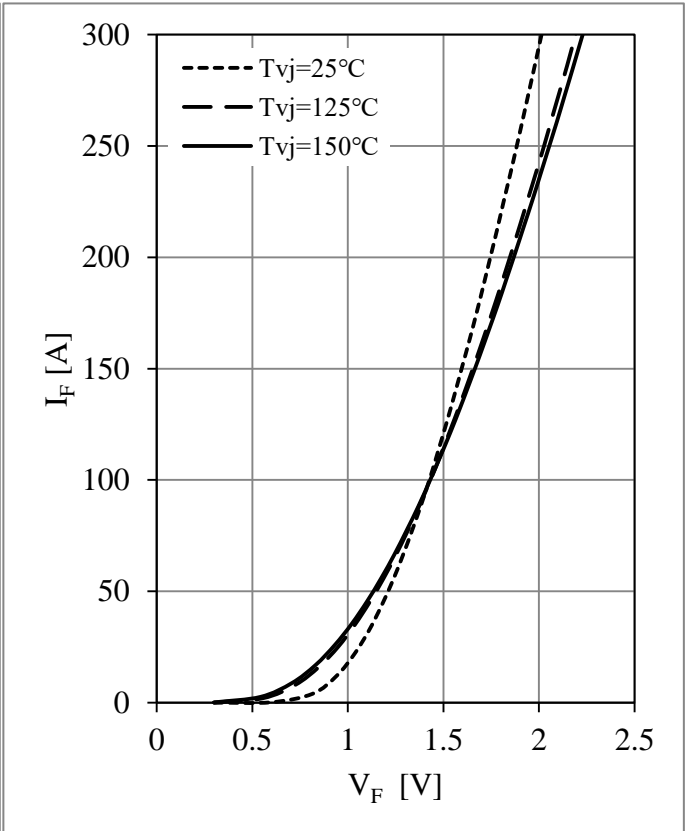

Fig 8. Diode Forward Characteristics

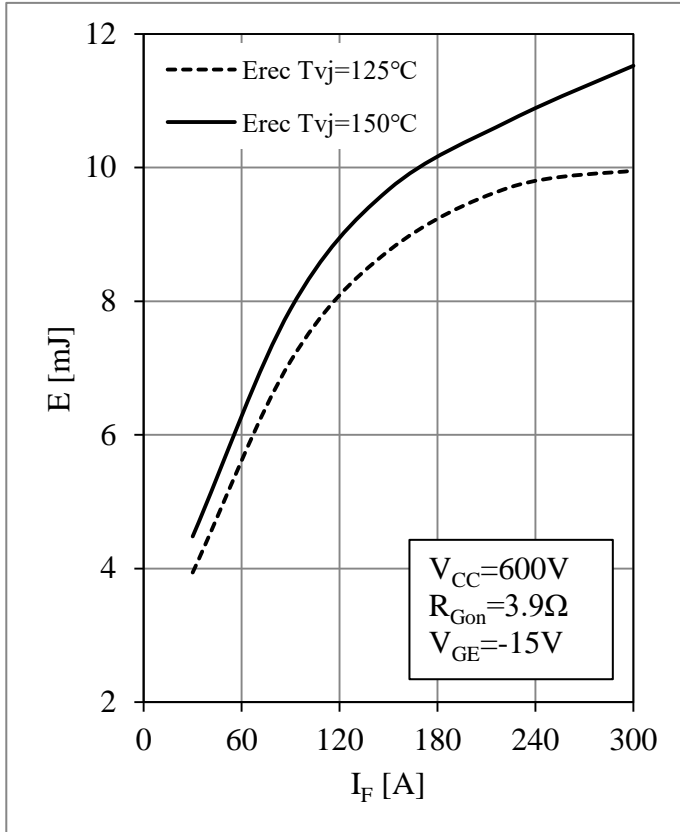

Fig 9. Diode Switching Loss vs.  $I_F$

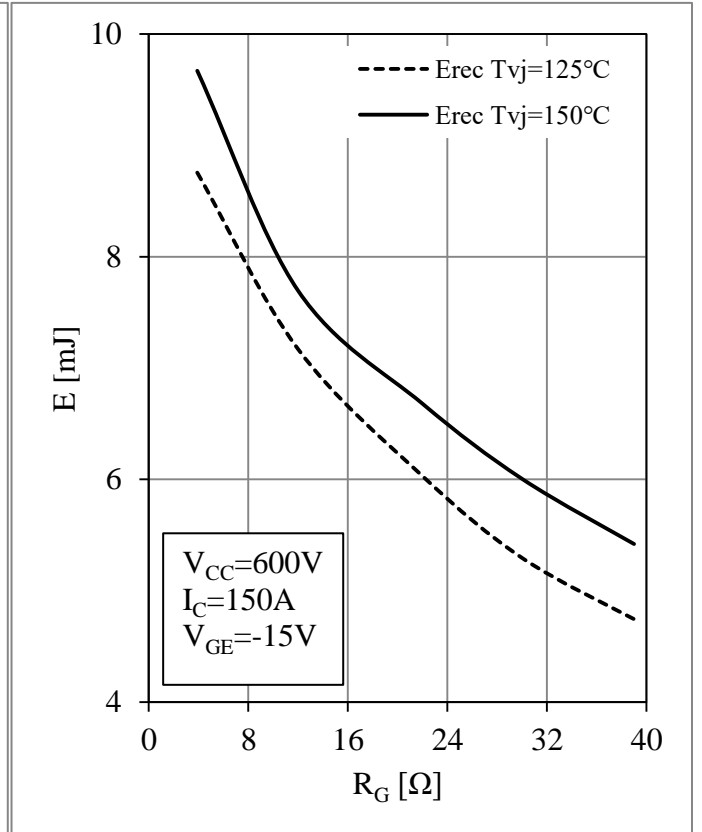

Fig 10. Diode Switching Loss vs.  $R_G$

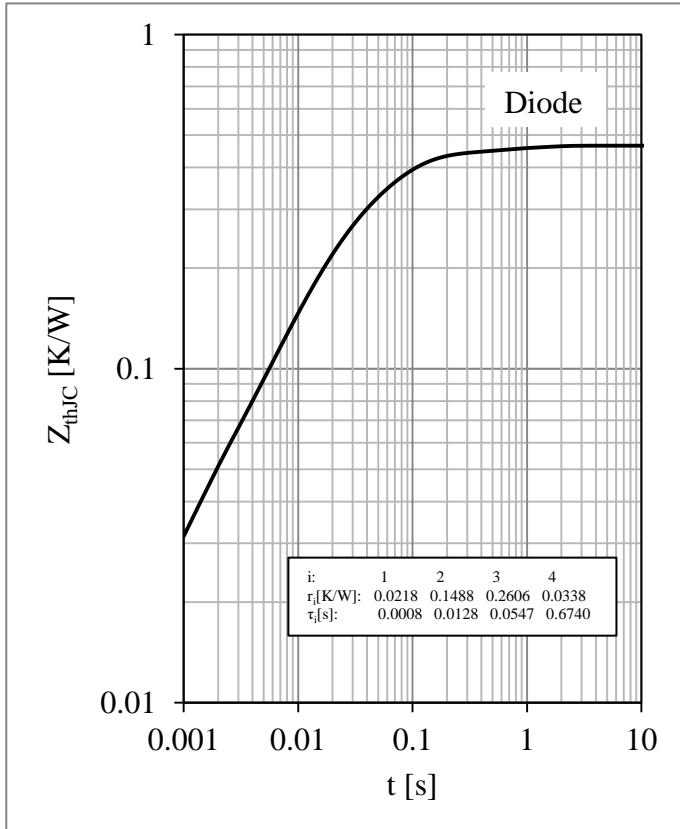

Fig 11. Diode Transient Thermal Impedance

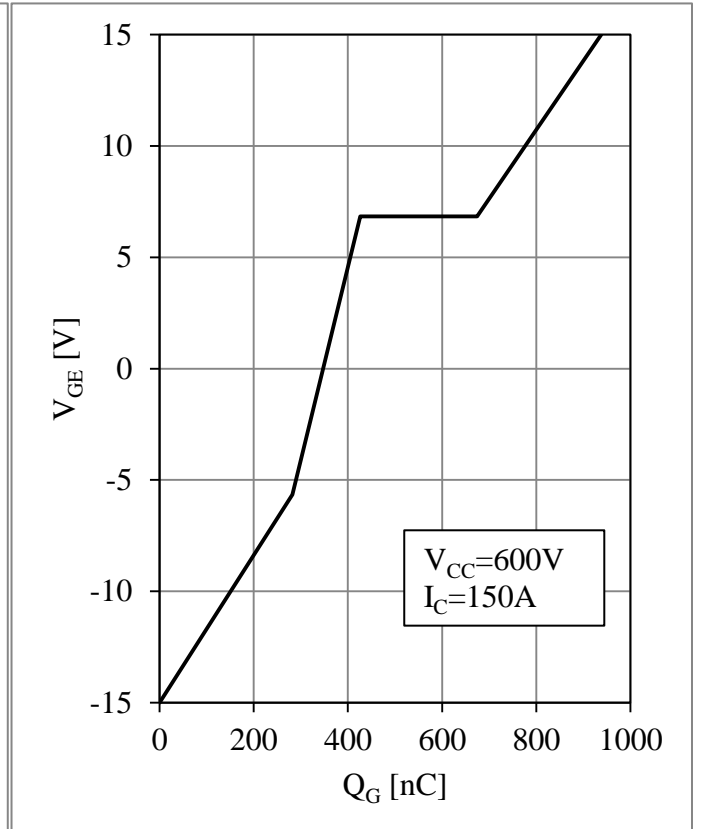

Fig 12. IGBT Gate Charge Characteristic

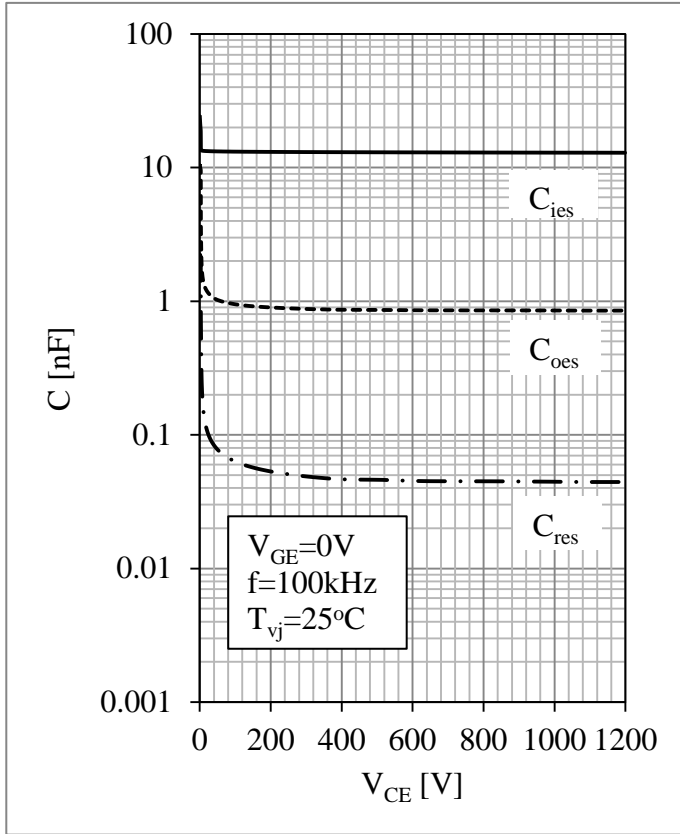

Fig 13. IGBT Capacity Characteristic

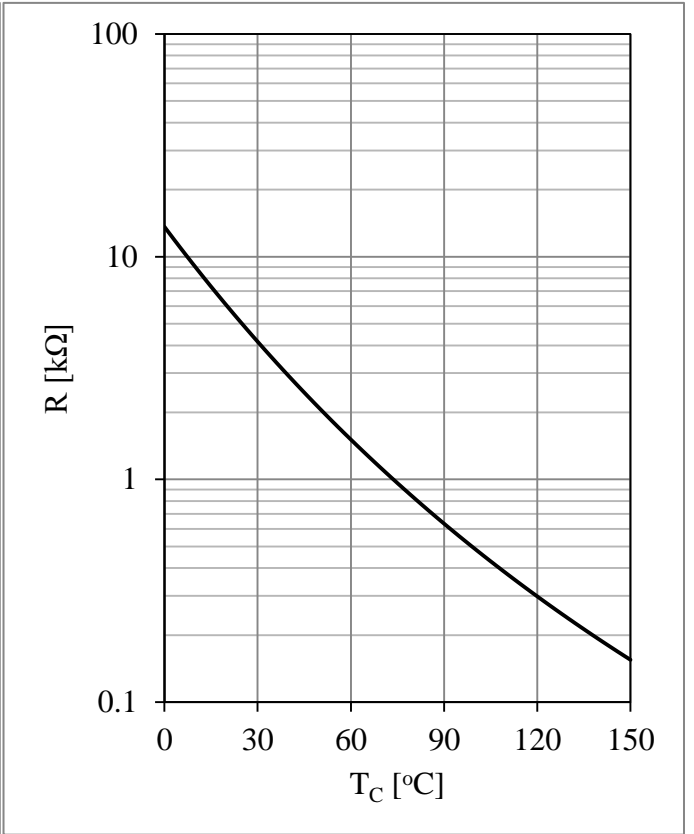
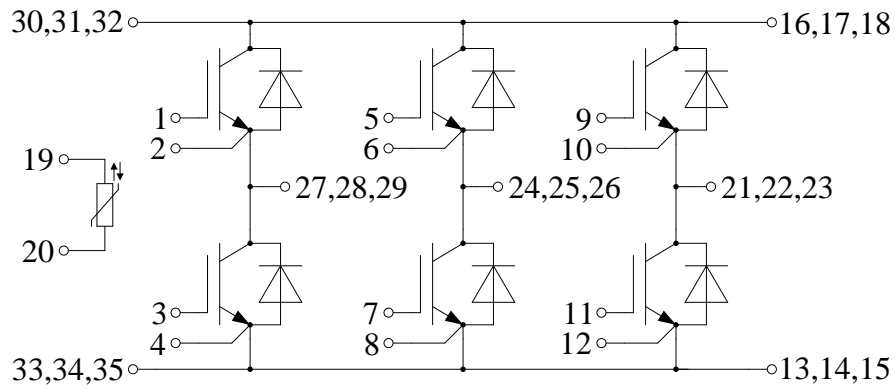

Fig 14. NTC Temperature Characteristic



**Circuit Schematic**



**Package Dimensions**

Dimensions in Millimeters

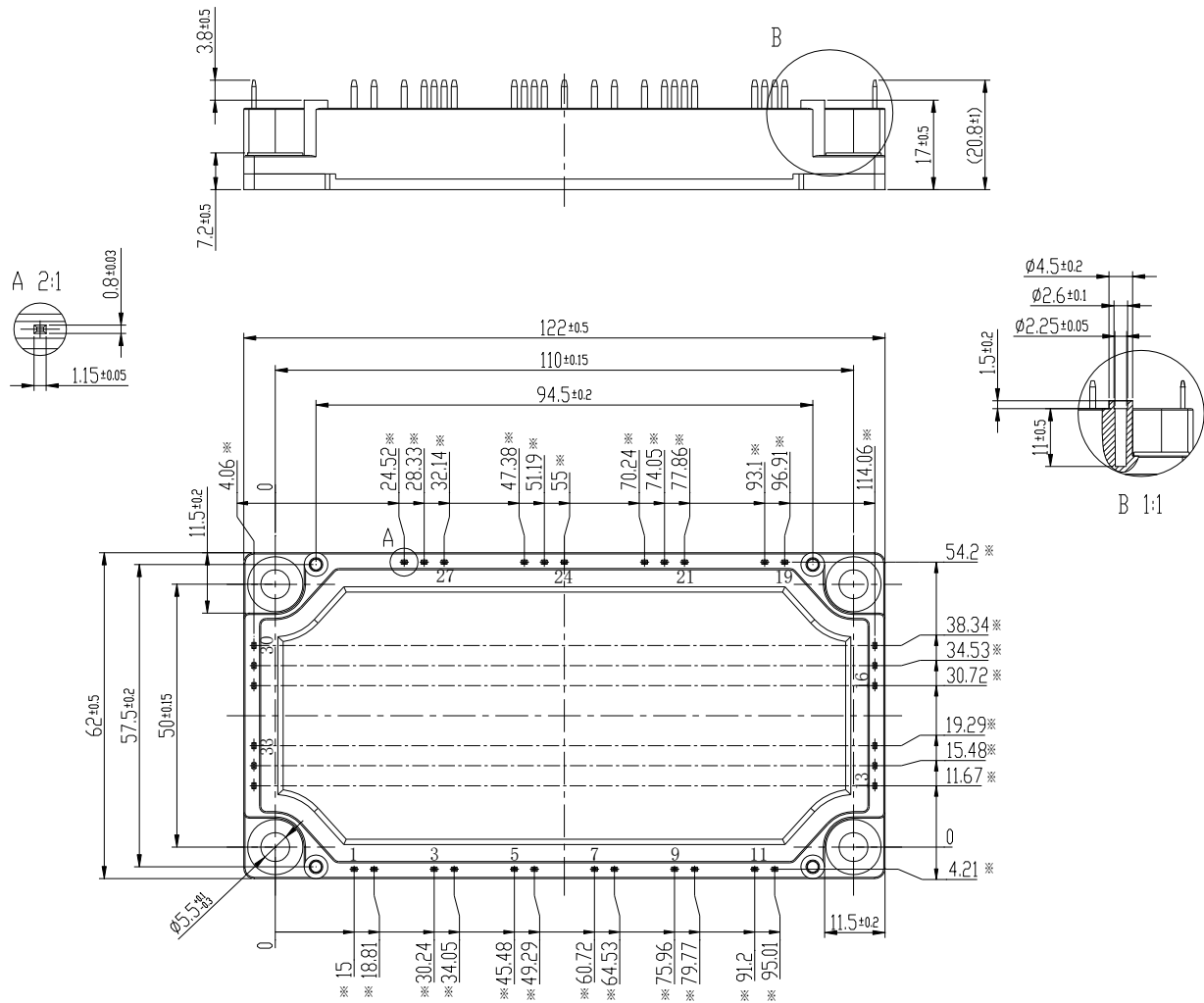

\*all dimensions with a tolerance of  $\pm 0.4$

Black package

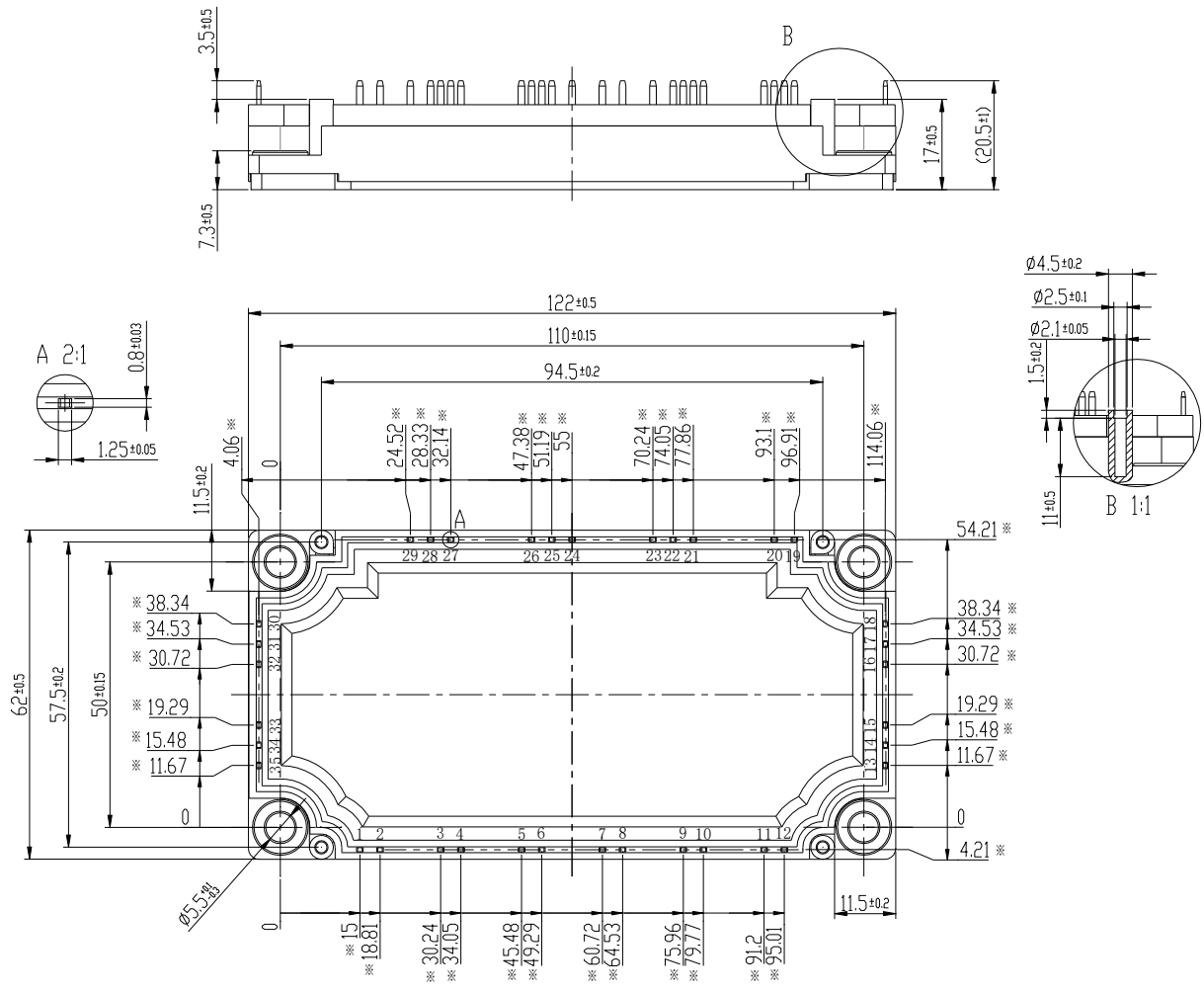

White package

## Terms and Conditions of Usage

The data contained in this product datasheet is exclusively intended for technically trained staff. you and your technical departments will have to evaluate the suitability of the product for the intended application and the completeness of the product data with respect to such application.

This product data sheet is describing the characteristics of this product for which a warranty is granted. Any such warranty is granted exclusively pursuant the terms and conditions of the supply agreement. There will be no guarantee of any kind for the product and its characteristics.

Should you require product information in excess of the data given in this product data sheet or which concerns the specific application of our product, please contact the sales office, which is responsible for you (see [www.powersemi.com](http://www.powersemi.com)), For those that are specifically interested we may provide application notes.

Due to technical requirements our product may contain dangerous substances. For information on the types in question please contact the sales office, which is responsible for you.

Should you intend to use the Product in aviation applications, in health or live endangering or life support applications, please notify.

If and to the extent necessary, please forward equivalent notices to your customers.  
Changes of this product data sheet are reserved.