

STARPOWER

SEMICONDUCTOR

IGBT

GD100PIA120C6SN

1200V/100A PIM in one-package

General Description

STARPOWER IGBT Power Module provides ultra low conduction loss as well as short circuit ruggedness. They are designed for the applications such as general inverters and UPS.

Features

- Low $V_{CE(sat)}$ Trench IGBT technology
- 8 μ s short circuit capability
- $V_{CE(sat)}$ with positive temperature coefficient
- Maximum junction temperature 175°C
- Low inductance case
- Fast & soft reverse recovery anti-parallel FWD
- Isolated copper baseplate using DBC technology

Typical Applications

- Inverter for motor drive
- AC and DC servo drive amplifier
- Uninterruptible power supply

Equivalent Circuit Schematic

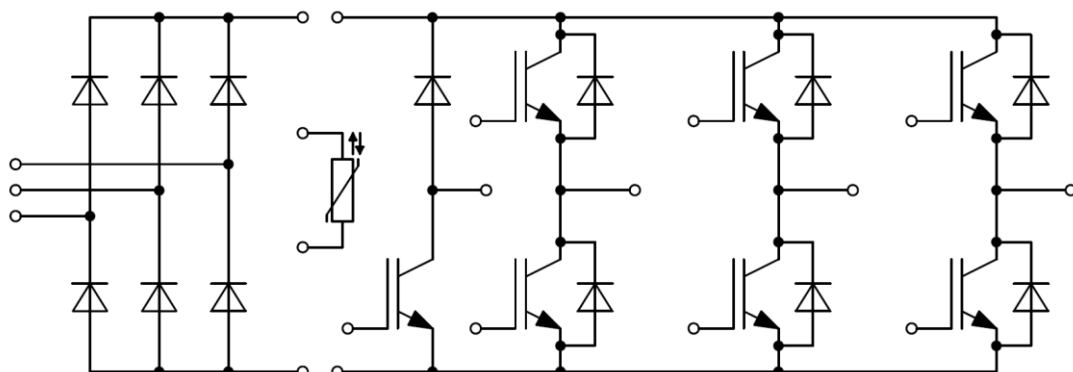

Absolute Maximum Ratings $T_C=25^{\circ}\text{C}$ unless otherwise noted**IGBT-inverter**

Symbol	Description	Value	Unit
V_{CES}	Collector-Emitter Voltage	1200	V
V_{GES}	Gate-Emitter Voltage	± 20	V
I_C	Collector Current @ $T_C=100^{\circ}\text{C}$	100	A
I_{CRM}	Repetitive Peak Collector Current tp limited by T_{vjop}	200	A

Diode-inverter

Symbol	Description	Value	Unit
V_{RRM}	Repetitive Peak Reverse Voltage	1200	V
I_F	Diode Continuous Forward Current	100	A
I_{FRM}	Repetitive Peak Forward Current tp limited by T_{vjop}	200	A

Diode-rectifier

Symbol	Description	Value	Unit
V_{RRM}	Repetitive Peak Reverse Voltage	1600	V
I_{FRMSM}	Maximum RMS Forward Current per Chip @ $T_C=110^{\circ}\text{C}$	100	A
I_{RMSM}	Maximum RMS Current at Rectifier Output @ $T_C=110^{\circ}\text{C}$	150	A
I_{FSM}	Surge Forward Current $t_p=10\text{ms}$ @ $T_{vj}=25^{\circ}\text{C}$ @ $T_{vj}=150^{\circ}\text{C}$	1150 880	A
I^2t	I^2t -value, $t_p=10\text{ms}$ @ $T_{vj}=25^{\circ}\text{C}$ @ $T_{vj}=150^{\circ}\text{C}$	6600 3850	A^2s

IGBT-brake

Symbol	Description	Value	Unit
V_{CES}	Collector-Emitter Voltage	1200	V
V_{GES}	Gate-Emitter Voltage	± 20	V
I_C	Collector Current @ $T_C=100^{\circ}\text{C}$	50	A
I_{CRM}	Repetitive Peak Collector Current tp limited by T_{vjop}	100	A

Diode-brake

Symbol	Description	Value	Unit
V_{RRM}	Repetitive Peak Reverse Voltage	1200	V
I_F	Diode Continuous Forward Current	25	A
I_{FRM}	Repetitive Peak Forward Current tp limited by T_{vjop}	50	A

Module

Symbol	Description	Value	Unit
T_{vjmax}	Maximum Junction Temperature(inverter,brake) Maximum Junction Temperature (rectifier)	175 150	$^{\circ}\text{C}$
T_{vjop}	Operating Junction Temperature(inverter,brake) Operating Junction Temperature(rectifier)	-40 to +175 -40 to +150	$^{\circ}\text{C}$
T_{STG}	Storage Temperature Range	-40 to +125	$^{\circ}\text{C}$
V_{ISO}	Isolation Voltage RMS, $f=50\text{Hz}$, $t=1\text{min}$	2500	V

Note: $T_{vjop} > 150^{\circ}\text{C}$ is allowed for operation at overload conditions.

IGBT-inverter Characteristics $T_C=25^\circ\text{C}$ unless otherwise noted

Symbol	Parameter	Test Conditions	Min.	Typ.	Max.	Unit	
$V_{CE(sat)}$	Collector to Emitter Saturation Voltage	$I_C=100\text{A}, V_{GE}=15\text{V}, T_{vj}=25^\circ\text{C}$		1.50	1.95	V	
		$I_C=100\text{A}, V_{GE}=15\text{V}, T_{vj}=125^\circ\text{C}$		1.70			
		$I_C=100\text{A}, V_{GE}=15\text{V}, T_{vj}=150^\circ\text{C}$		1.80			
$V_{GE(th)}$	Gate-Emitter Threshold Voltage	$I_C=2.0\text{mA}, V_{CE}=V_{GE}, T_{vj}=25^\circ\text{C}$	5.4	6.2	7.0	V	
I_{CES}	Collector Cut-Off Current	$V_{CE}=V_{CES}, V_{GE}=0\text{V}, T_{vj}=25^\circ\text{C}$			50	μA	
I_{GES}	Gate-Emitter Leakage Current	$V_{GE}=V_{GES}, V_{CE}=0\text{V}, T_{vj}=25^\circ\text{C}$			100	nA	
R_{Gint}	Internal Gate Resistance			0		Ω	
C_{ies}	Input Capacitance	$V_{CE}=25\text{V}, f=1\text{MHz}, V_{GE}=0\text{V}$		8.84		nF	
C_{res}	Reverse Transfer Capacitance				0.08		nF
Q_G	Gate Charge	$V_{GE}=-15\dots+15\text{V}$		0.64		μC	
$t_{d(on)}$	Turn-On Delay Time	$V_{CC}=600\text{V}, I_C=100\text{A}, R_G=3.9\Omega, L_S=35\text{nH}, V_{GE}=\pm 15\text{V}, T_{vj}=25^\circ\text{C}$		62		ns	
t_r	Rise Time			26		ns	
$t_{d(off)}$	Turn-Off Delay Time			275		ns	
t_f	Fall Time			175		ns	
E_{on}	Turn-On Switching Loss			3.81		mJ	
E_{off}	Turn-Off Switching Loss			8.67		mJ	
$t_{d(on)}$	Turn-On Delay Time		$V_{CC}=600\text{V}, I_C=100\text{A}, R_G=3.9\Omega, L_S=35\text{nH}, V_{GE}=\pm 15\text{V}, T_{vj}=125^\circ\text{C}$		66		ns
t_r	Rise Time				29		ns
$t_{d(off)}$	Turn-Off Delay Time			331		ns	
t_f	Fall Time			279		ns	
E_{on}	Turn-On Switching Loss			5.57		mJ	
E_{off}	Turn-Off Switching Loss			11.6		mJ	
$t_{d(on)}$	Turn-On Delay Time	$V_{CC}=600\text{V}, I_C=100\text{A}, R_G=3.9\Omega, L_S=35\text{nH}, V_{GE}=\pm 15\text{V}, T_{vj}=150^\circ\text{C}$			67		ns
t_r	Rise Time				30		ns
$t_{d(off)}$	Turn-Off Delay Time			341		ns	
t_f	Fall Time			306		ns	
E_{on}	Turn-On Switching Loss			6.00		mJ	
E_{off}	Turn-Off Switching Loss			12.1		mJ	
I_{SC}	SC Data		$t_p \leq 8\mu\text{s}, V_{GE}=15\text{V}, T_{vj}=150^\circ\text{C}, V_{CC}=600\text{V}, V_{CEM} \leq 1200\text{V}$		300		A

Diode-inverter Characteristics $T_C=25^\circ\text{C}$ unless otherwise noted

Symbol	Parameter	Test Conditions	Min.	Typ.	Max.	Unit
V_F	Diode Forward Voltage	$I_F=100\text{A}, V_{GE}=0\text{V}, T_{vj}=25^\circ\text{C}$		1.60	2.05	V
		$I_F=100\text{A}, V_{GE}=0\text{V}, T_{vj}=125^\circ\text{C}$		1.65		
		$I_F=100\text{A}, V_{GE}=0\text{V}, T_{vj}=150^\circ\text{C}$		1.65		
Q_r	Recovered Charge			7.49		μC
I_{RM}	Peak Reverse Recovery Current	$V_R=600\text{V}, I_F=100\text{A},$ $-di/dt=3743\text{A}/\mu\text{s}, L_S=35\text{nH},$ $V_{GE}=-15\text{V}, T_{vj}=25^\circ\text{C}$		105		A
E_{rec}	Reverse Recovery Energy			3.27		mJ
Q_r	Recovered Charge			12.8		μC
I_{RM}	Peak Reverse Recovery Current	$V_R=600\text{V}, I_F=100\text{A},$ $-di/dt=3450\text{A}/\mu\text{s}, L_S=35\text{nH},$ $V_{GE}=-15\text{V}, T_{vj}=125^\circ\text{C}$		114		A
E_{rec}	Reverse Recovery Energy			5.58		mJ
Q_r	Recovered Charge			14.5		μC
I_{RM}	Peak Reverse Recovery Current	$V_R=600\text{V}, I_F=100\text{A},$ $-di/dt=3405\text{A}/\mu\text{s}, L_S=35\text{nH},$ $V_{GE}=-15\text{V}, T_{vj}=150^\circ\text{C}$		119		A
E_{rec}	Reverse Recovery Energy			6.32		mJ

Diode-rectifier Characteristics $T_C=25^\circ\text{C}$ unless otherwise noted

Symbol	Parameter	Test Conditions	Min.	Typ.	Max.	Unit
V_F	Diode Forward Voltage	$I_F=100\text{A}, V_{GE}=0\text{V}, T_{vj}=150^\circ\text{C}$		0.95		V
I_R	Reverse Current	$T_{vj}=150^\circ\text{C}, V_R=1600\text{V}$			2.0	mA

IGBT-brake Characteristics $T_C=25^\circ\text{C}$ unless otherwise noted

Symbol	Parameter	Test Conditions	Min.	Typ.	Max.	Unit
$V_{CE(sat)}$	Collector to Emitter Saturation Voltage	$I_C=50\text{A}, V_{GE}=15\text{V}, T_{vj}=25^\circ\text{C}$		1.50	1.95	V
		$I_C=50\text{A}, V_{GE}=15\text{V}, T_{vj}=125^\circ\text{C}$		1.70		
		$I_C=50\text{A}, V_{GE}=15\text{V}, T_{vj}=150^\circ\text{C}$		1.80		
$V_{GE(th)}$	Gate-Emitter Threshold Voltage	$I_C=1.00\text{mA}, V_{CE}=V_{GE}, T_{vj}=25^\circ\text{C}$	5.3	6.2	7.0	V
I_{CES}	Collector Cut-Off Current	$V_{CE}=V_{CES}, V_{GE}=0\text{V}, T_{vj}=25^\circ\text{C}$			50	μA
I_{GES}	Gate-Emitter Leakage Current	$V_{GE}=V_{GES}, V_{CE}=0\text{V}, T_{vj}=25^\circ\text{C}$			100	nA
R_{Gint}	Internal Gate Resistance			0		Ω
C_{ies}	Input Capacitance	$V_{CE}=25\text{V}, f=1\text{MHz}, V_{GE}=0\text{V}$		4.42		nF
C_{res}	Reverse Transfer Capacitance				0.04	
Q_G	Gate Charge	$V_{GE}=-15\dots+15\text{V}$		0.32		μC
$t_{d(on)}$	Turn-On Delay Time	$V_{CC}=600\text{V}, I_C=50\text{A}, R_G=18\Omega, L_S=35\text{nH}, V_{GE}=\pm 15\text{V}, T_{vj}=25^\circ\text{C}$		68		ns
t_r	Rise Time			39		ns
$t_{d(off)}$	Turn-Off Delay Time			303		ns
t_f	Fall Time			165		ns
E_{on}	Turn-On Switching Loss			4.77		mJ
E_{off}	Turn-Off Switching Loss			3.64		mJ
$t_{d(on)}$	Turn-On Delay Time	$V_{CC}=600\text{V}, I_C=50\text{A}, R_G=18\Omega, L_S=35\text{nH}, V_{GE}=\pm 15\text{V}, T_{vj}=125^\circ\text{C}$		69		ns
t_r	Rise Time			42		ns
$t_{d(off)}$	Turn-Off Delay Time			370		ns
t_f	Fall Time			268		ns
E_{on}	Turn-On Switching Loss			6.06		mJ
E_{off}	Turn-Off Switching Loss			5.35		mJ
$t_{d(on)}$	Turn-On Delay Time	$V_{CC}=600\text{V}, I_C=50\text{A}, R_G=18\Omega, L_S=35\text{nH}, V_{GE}=\pm 15\text{V}, T_{vj}=150^\circ\text{C}$		70		ns
t_r	Rise Time			44		ns
$t_{d(off)}$	Turn-Off Delay Time			380		ns
t_f	Fall Time			291		ns
E_{on}	Turn-On Switching Loss			6.45		mJ
E_{off}	Turn-Off Switching Loss			5.65		mJ
I_{SC}	SC Data	$t_p \leq 8\mu\text{s}, V_{GE}=15\text{V}, T_{vj}=150^\circ\text{C}, V_{CC}=600\text{V}, V_{CEM} \leq 1200\text{V}$		150		A

Diode-brake Characteristics $T_C=25^{\circ}\text{C}$ unless otherwise noted

Symbol	Parameter	Test Conditions	Min.	Typ.	Max.	Unit
V_F	Diode Forward Voltage	$I_F=25\text{A}, V_{GE}=0\text{V}, T_{vj}=25^{\circ}\text{C}$		1.60	2.05	V
		$I_F=25\text{A}, V_{GE}=0\text{V}, T_{vj}=125^{\circ}\text{C}$		1.65		
		$I_F=25\text{A}, V_{GE}=0\text{V}, T_{vj}=150^{\circ}\text{C}$		1.65		

NTC Characteristics $T_C=25^{\circ}\text{C}$ unless otherwise noted

Symbol	Parameter	Test Conditions	Min.	Typ.	Max.	Unit
R_{25}	Rated Resistance			5.0		k Ω
$\Delta R/R$	Deviation of R_{100}	$T_C=100^{\circ}\text{C}, R_{100}=493.3\Omega$	-5		5	%
P_{25}	Power Dissipation				20.0	mW
$B_{25/50}$	B-value	$R_2=R_{25}\exp[B_{25/50}(1/T_2-1/(298.15\text{K}))]$		3375		K
$B_{25/80}$	B-value	$R_2=R_{25}\exp[B_{25/80}(1/T_2-1/(298.15\text{K}))]$		3411		K
$B_{25/100}$	B-value	$R_2=R_{25}\exp[B_{25/100}(1/T_2-1/(298.15\text{K}))]$		3433		K

Module Characteristics $T_C=25^{\circ}\text{C}$ unless otherwise noted

Symbol	Parameter	Min.	Typ.	Max.	Unit
L_{CE}	Stray Inductance		40		nH
$R_{CC'+EE'}$ $R_{AA'+CC'}$	Module Lead Resistance, Terminal to Chip		4.00 3.00		m Ω
R_{thJC}	Junction-to-Case (per IGBT-inverter)			0.285	K/W
	Junction-to-Case (per Diode-inverter)			0.515	
	Junction-to-Case (per Diode-rectifier)			0.408	
	Junction-to-Case (per IGBT-brake)			0.440	
	Junction-to-Case (per Diode-brake)			1.152	
R_{thCH}	Case-to-Sink (per IGBT-inverter)		0.159		K/W
	Case-to-Sink (per Diode-inverter)		0.176		
	Case-to-Sink (per Diode-rectifier)		0.163		
	Case-to-Sink (per IGBT-brake)		0.164		
	Case-to-Sink (per Diode-brake)		0.182		
M	Mounting Torque, Screw:M5	3.0		6.0	N.m
G	Weight of Module		300		g

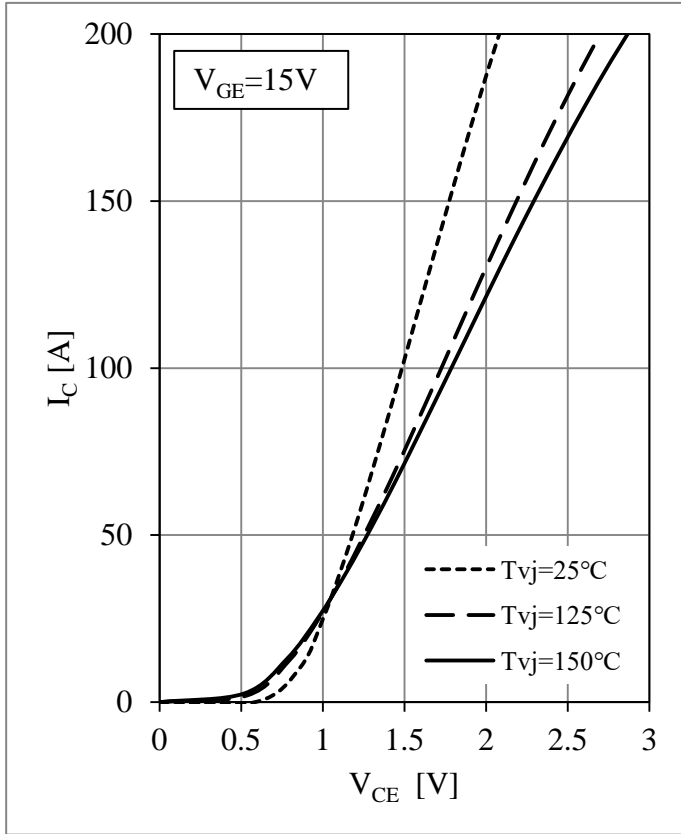

Fig 1. IGBT-inverter Output Characteristics

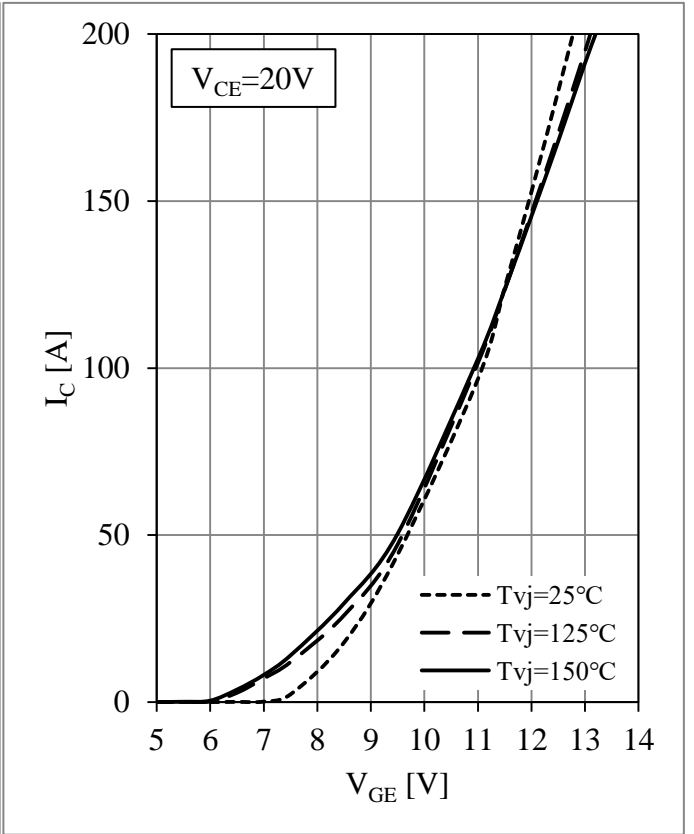

Fig 2. IGBT-inverter Transfer Characteristics

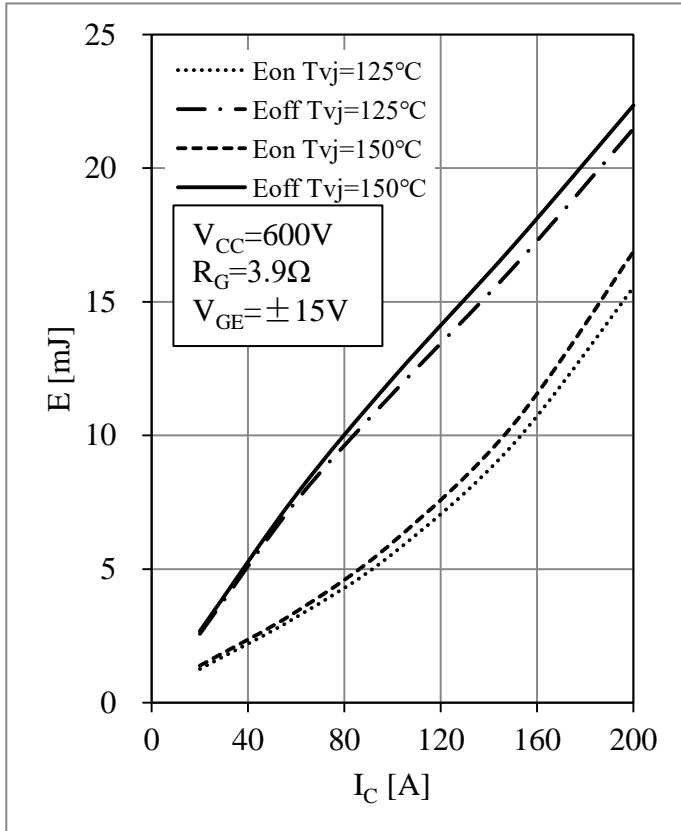

Fig 3. IGBT-inverter Switching Loss vs. I_C

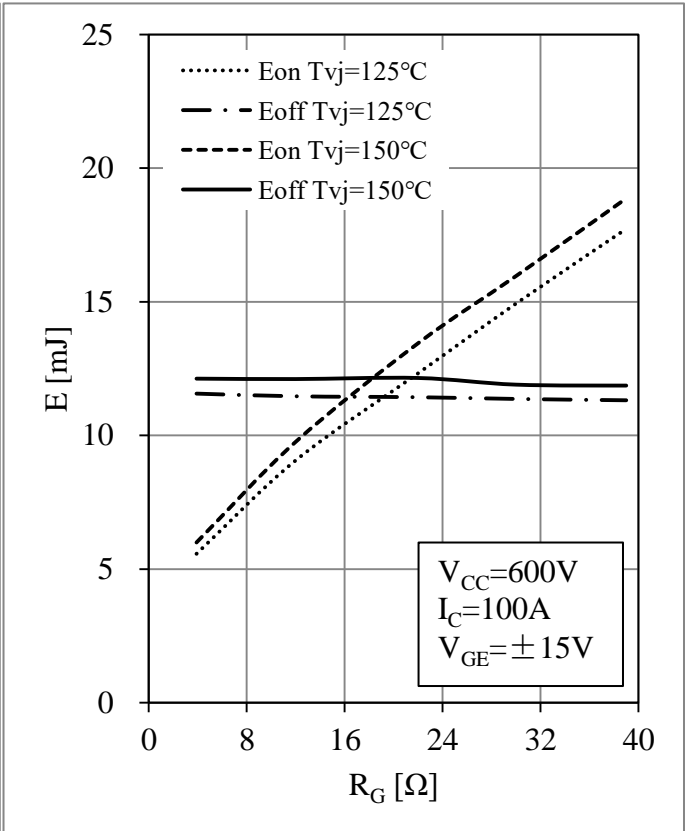

Fig 4. IGBT-inverter Switching Loss vs. R_G

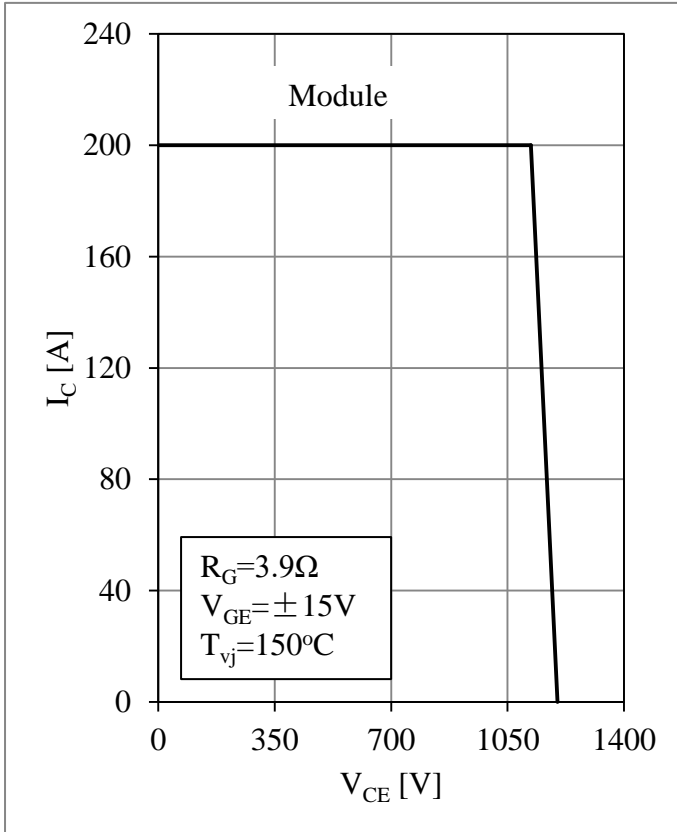

Fig 5. IGBT-inverter RBSOA

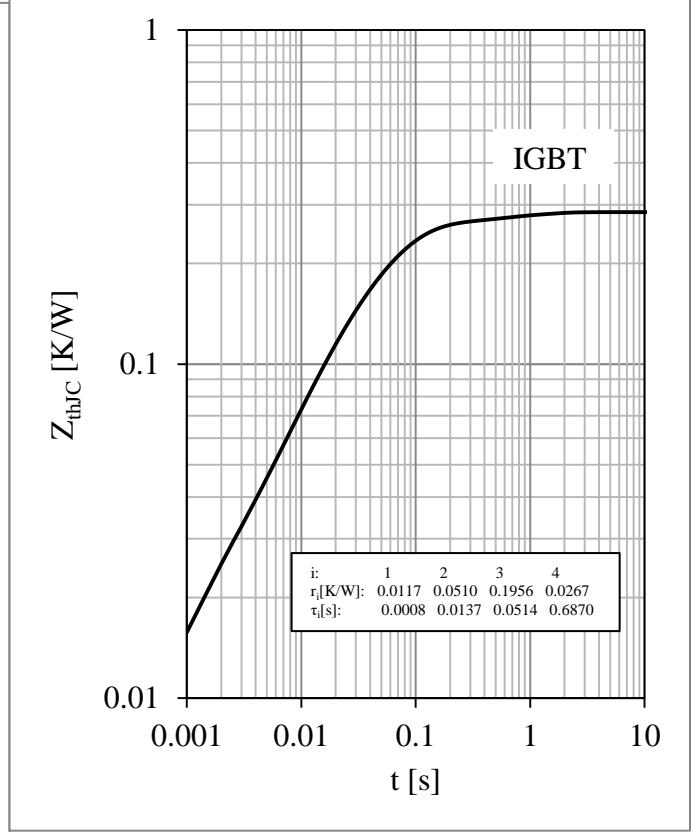

Fig 6. IGBT-inverter Transient Thermal Impedance

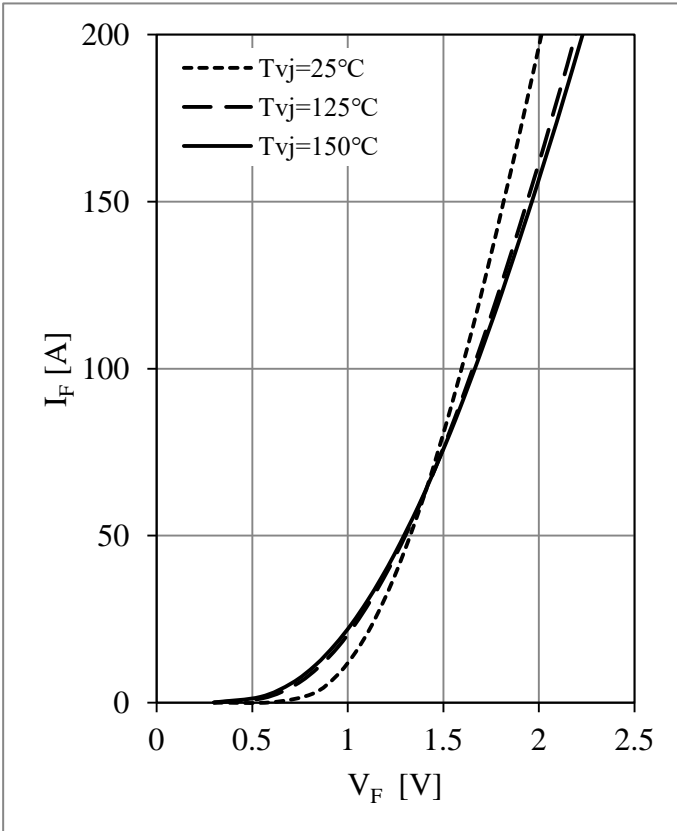

Fig 7. Diode-inverter Forward Characteristics

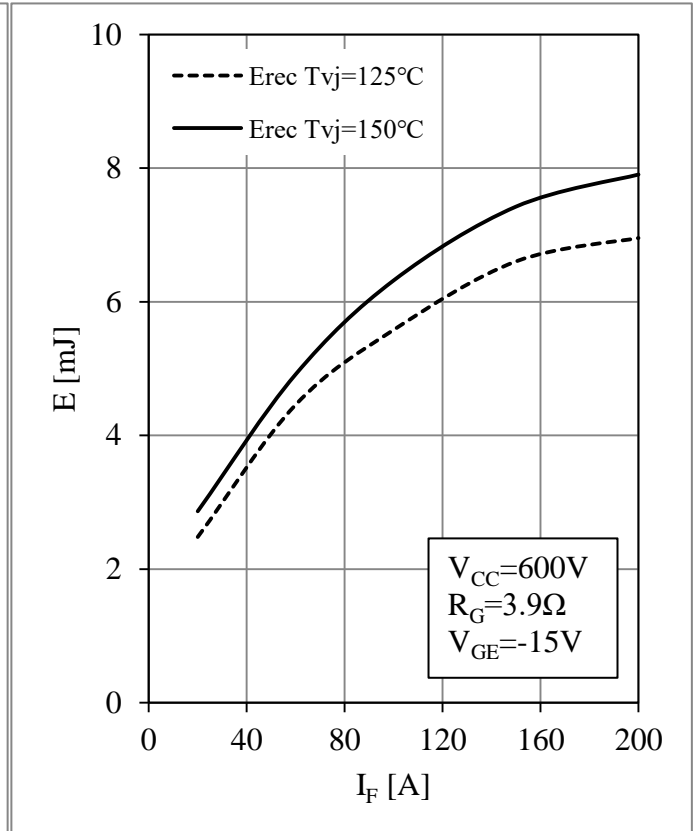

Fig 8. Diode-inverter Switching Loss vs. I_F

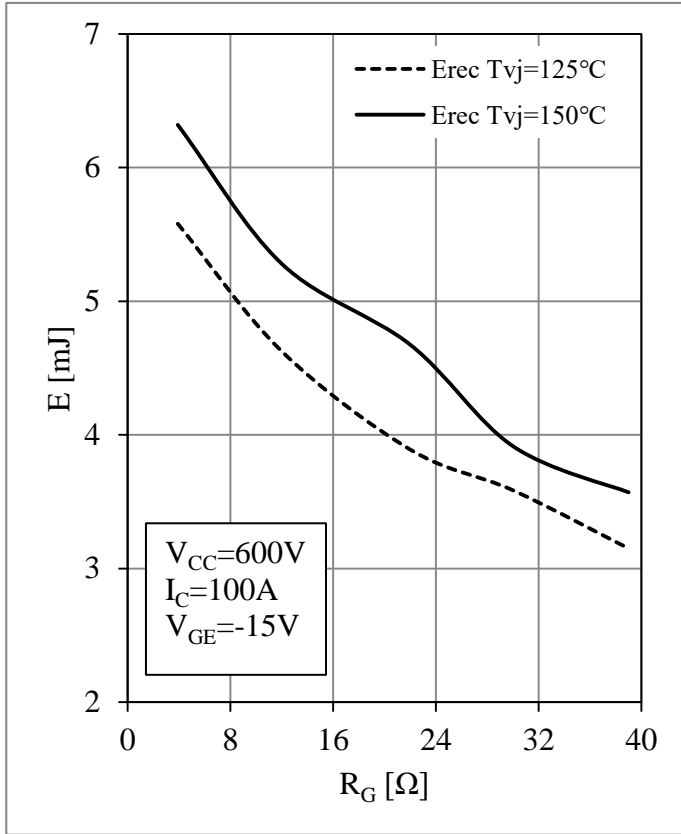

Fig 9. Diode-inverter Switching Loss vs. R_G

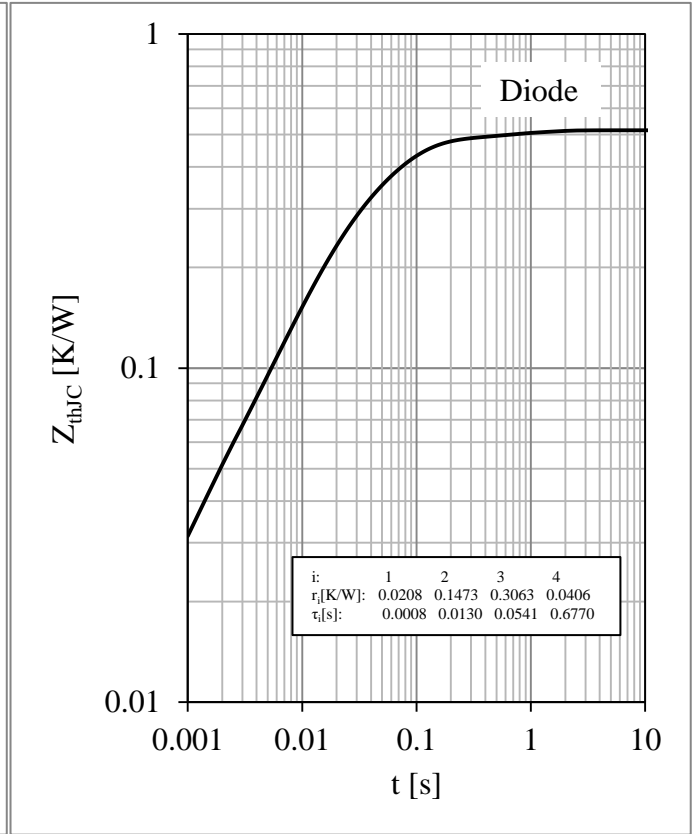

Fig 10. Diode-inverter Transient Thermal Impedance

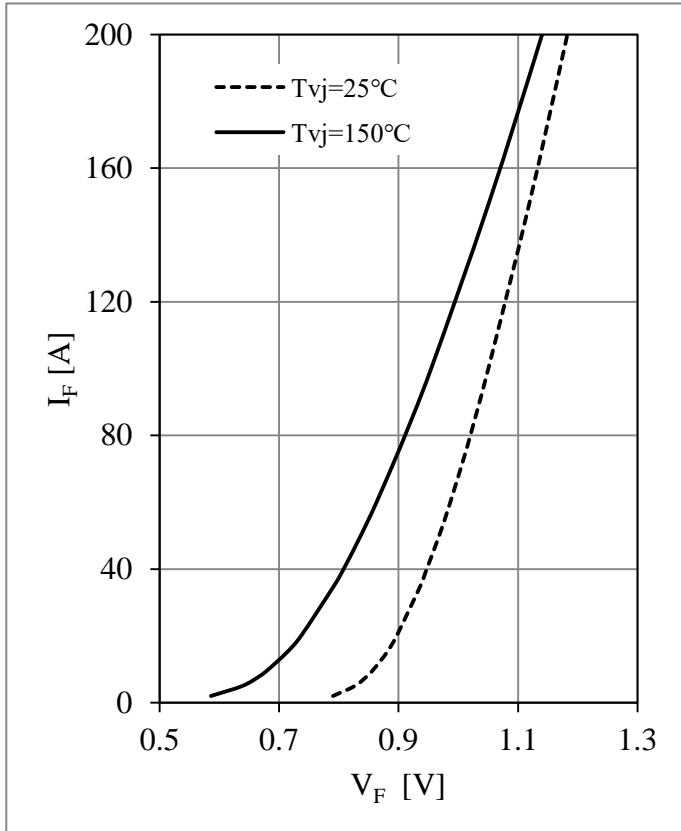

Fig 11. Diode-rectifier Forward Characteristics

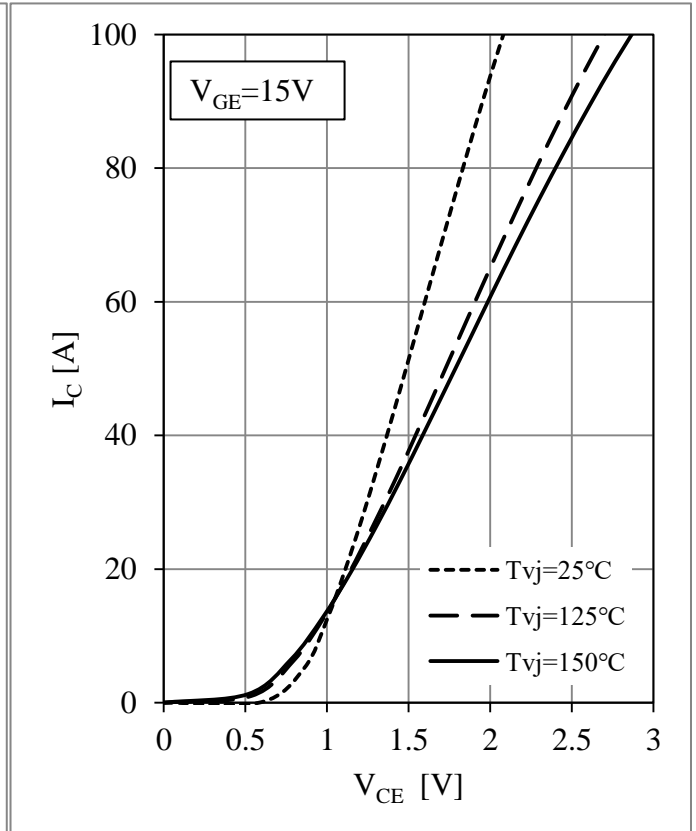

Fig 12. IGBT-brake-chopper Output Characteristics

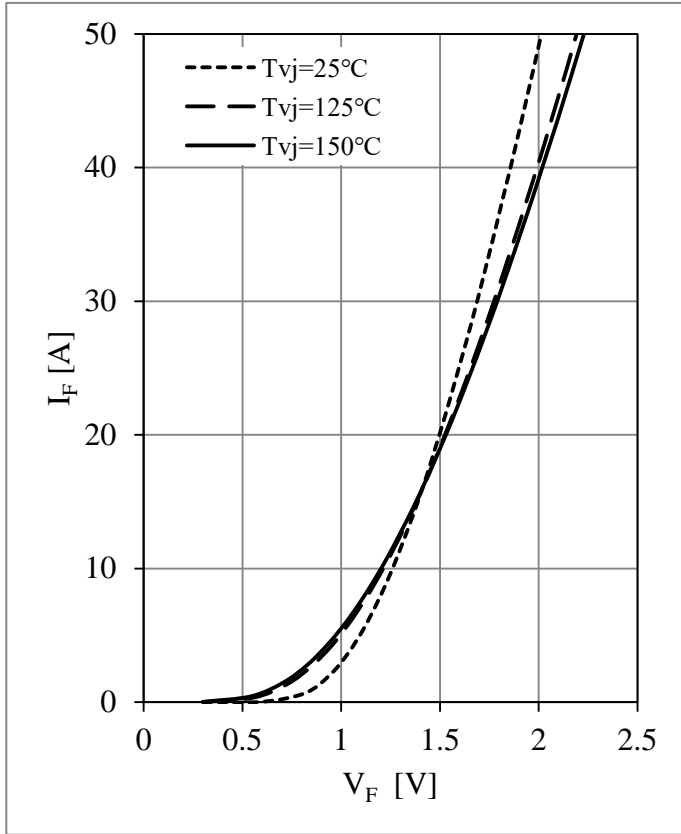

Fig 13. Diode-brake-chopper Forward Characteristics

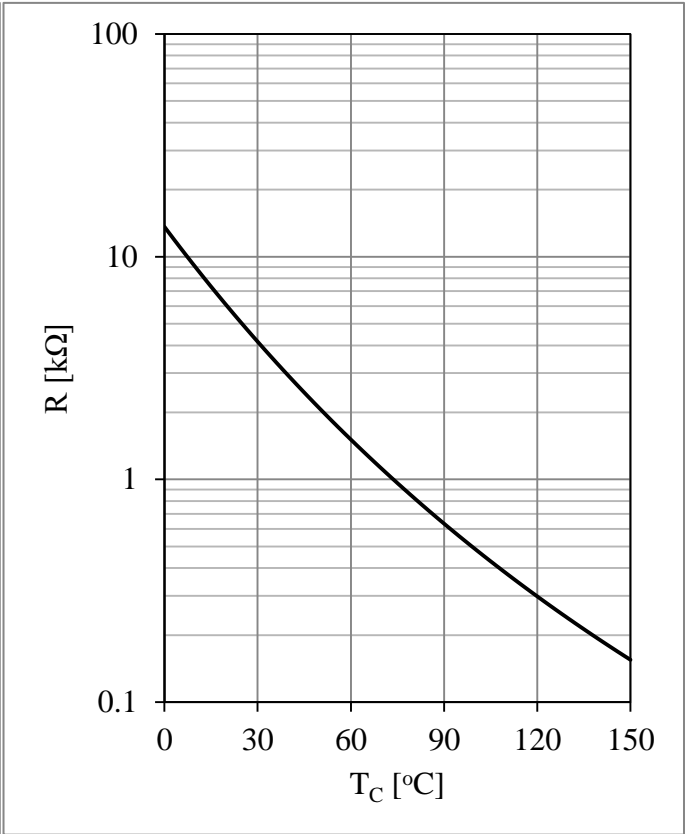
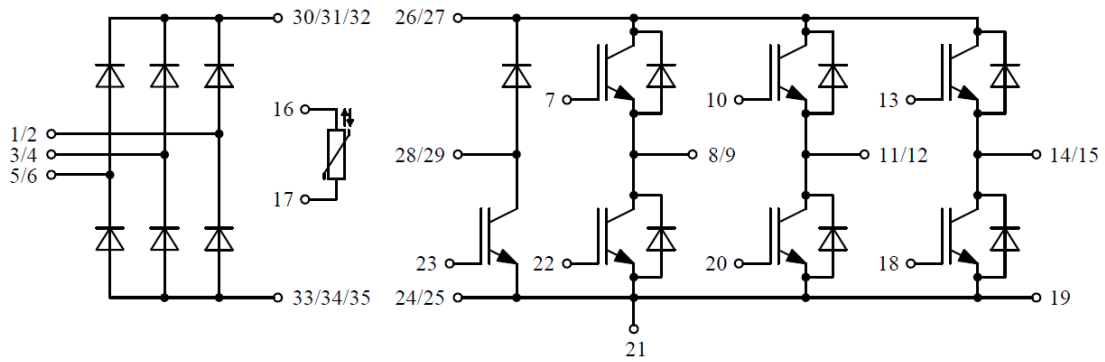

Fig 14. NTC Temperature Characteristic

Circuit Schematic



Package Dimensions

Dimensions in Millimeters

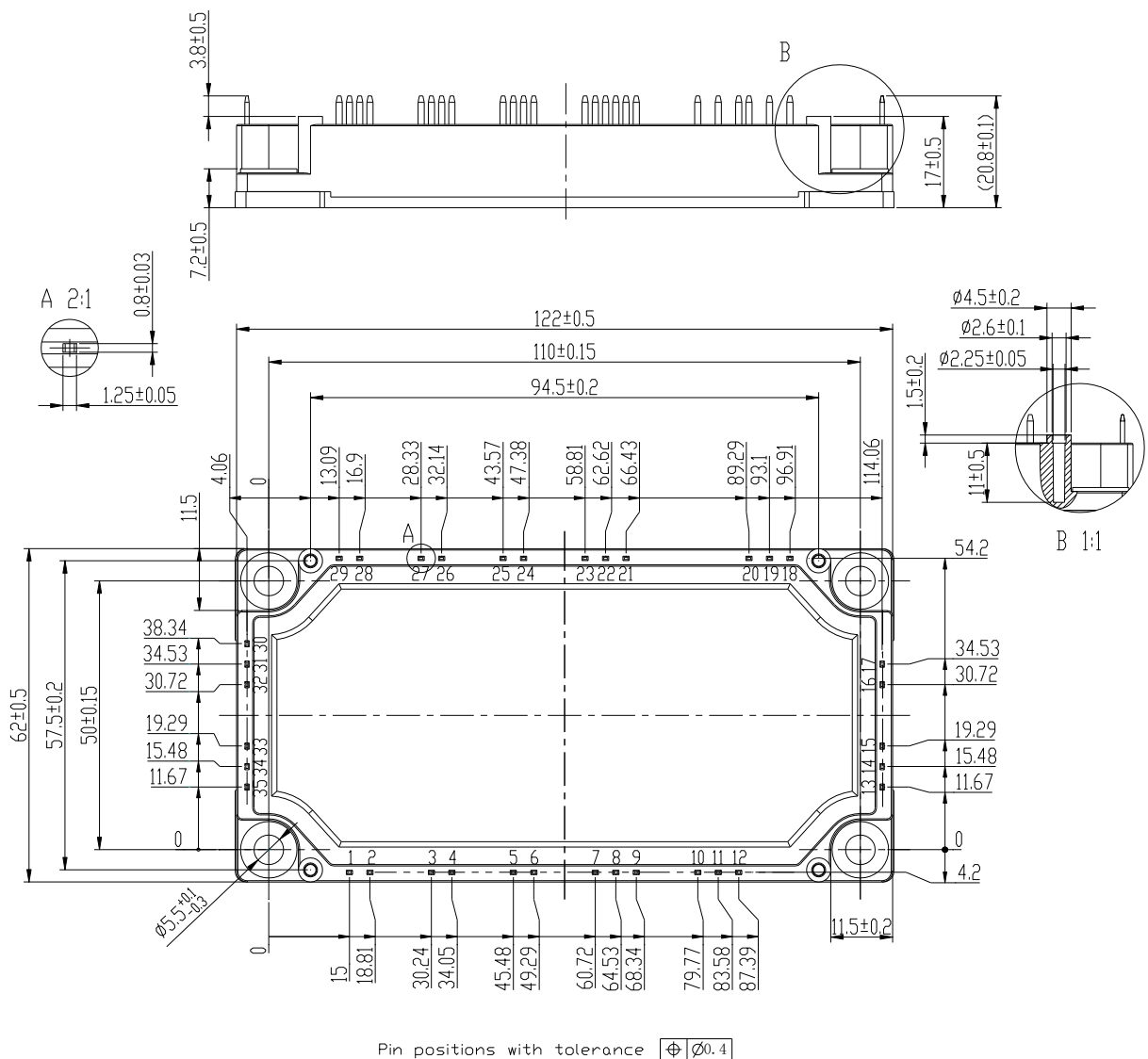

Terms and Conditions of Usage

The data contained in this product datasheet is exclusively intended for technically trained staff. you and your technical departments will have to evaluate the suitability of the product for the intended application and the completeness of the product data with respect to such application.

This product data sheet is describing the characteristics of this product for which a warranty is granted. Any such warranty is granted exclusively pursuant the terms and conditions of the supply agreement. There will be no guarantee of any kind for the product and its characteristics.

Should you require product information in excess of the data given in this product data sheet or which concerns the specific application of our product, please contact the sales office, which is responsible for you (see www.powersemi.cc), For those that are specifically interested we may provide application notes.

Due to technical requirements our product may contain dangerous substances. For information on the types in question please contact the sales office, which is responsible for you.

Should you intend to use the Product in aviation applications, in health or live endangering or life support applications, please notify.

If and to the extent necessary, please forward equivalent notices to your customers.
Changes of this product data sheet are reserved.