

STARPOWER

SEMICONDUCTOR

IGBT

GD1000HFA120C6S

1200V/1000A 2 in one-package

General Description

STARPOWER IGBT Power Module provides ultra low conduction loss as well as short circuit ruggedness. They are designed for the applications such as hybrid and electric vehicle.

Features

- Low $V_{CE(sat)}$ Trench IGBT technology
- Short circuit capability
- $V_{CE(sat)}$ with positive temperature coefficient
- Maximum junction temperature 175°C
- Low inductance case
- Fast & soft reverse recovery anti-parallel FWD
- Isolated copper pinfin baseplate using AMB technology

Typical Applications

- Hybrid and electric vehicle
- Inverter for motor drive
- Uninterruptible power supply

Equivalent Circuit Schematic

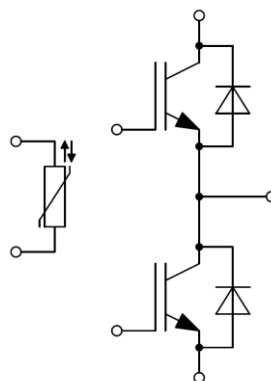

Absolute Maximum Ratings $T_F=25^{\circ}\text{C}$ unless otherwise noted**IGBT**

Symbol	Description	Values	Unit
V_{CES}	Collector-Emitter Voltage	1200	V
V_{GES}	Gate-Emitter Voltage	± 20	V
I_{CN}	Implemented Collector Current	1000	A
I_C	Collector Current @ $T_F=75^{\circ}\text{C}$	765	A
I_{CM}	Pulsed Collector Current $t_p=1\text{ms}$	2000	A
P_D	Maximum Power Dissipation @ $T_F=75^{\circ}\text{C}, T_j=175^{\circ}\text{C}$	1515	W

Diode

Symbol	Description	Values	Unit
V_{RRM}	Repetitive Peak Reverse Voltage	1200	V
I_{FN}	Implemented Collector Current	1000	A
I_F	Diode Continuous Forward Current	765	A
I_{FM}	Diode Maximum Forward Current $t_p=1\text{ms}$	2000	A
I_{FSM}	Surge Forward Current $t_p=10\text{ms}$ @ $T_j=25^{\circ}\text{C}$ @ $T_j=150^{\circ}\text{C}$	4100 3000	A
I^2t	I^2t -value, $t_p=10\text{ms}$ @ $T_j=25^{\circ}\text{C}$ @ $T_j=150^{\circ}\text{C}$	84000 45000	A^2s

Module

Symbol	Description	Value	Unit
T_{jmax}	Maximum Junction Temperature	175	$^{\circ}\text{C}$
T_{jop}	Operating Junction Temperature	-40 to +150	$^{\circ}\text{C}$
T_{STG}	Storage Temperature Range	-40 to +125	$^{\circ}\text{C}$
V_{ISO}	Isolation Voltage RMS, $f=50\text{Hz}, t=1\text{min}$	2500	V

IGBT Characteristics $T_F=25^{\circ}\text{C}$ unless otherwise noted

Symbol	Parameter	Test Conditions	Min.	Typ.	Max.	Unit	
$V_{CE(sat)}$	Collector to Emitter Saturation Voltage	$I_C=1000\text{A}, V_{GE}=15\text{V}, T_j=25^{\circ}\text{C}$		1.45	1.90	V	
		$I_C=1000\text{A}, V_{GE}=15\text{V}, T_j=125^{\circ}\text{C}$		1.65			
		$I_C=1000\text{A}, V_{GE}=15\text{V}, T_j=175^{\circ}\text{C}$		1.80			
$V_{GE(th)}$	Gate-Emitter Threshold Voltage	$I_C=24.0\text{mA}, V_{CE}=V_{GE}, T_j=25^{\circ}\text{C}$	5.5	6.3	7.0	V	
I_{CES}	Collector Cut-Off Current	$V_{CE}=V_{CES}, V_{GE}=0\text{V}, T_j=25^{\circ}\text{C}$			1.0	mA	
I_{GES}	Gate-Emitter Leakage Current	$V_{GE}=V_{GES}, V_{CE}=0\text{V}, T_j=25^{\circ}\text{C}$			400	nA	
R_{Gint}	Internal Gate Resistance			0.5		Ω	
C_{ies}	Input Capacitance	$V_{CE}=25\text{V}, f=100\text{kHz}, V_{GE}=0\text{V}$		51.5		nF	
C_{res}	Reverse Transfer Capacitance				0.36		nF
Q_G	Gate Charge	$V_{GE}=-15\dots+15\text{V}$		13.6		μC	
$t_{d(on)}$	Turn-On Delay Time	$V_{CC}=600\text{V}, I_C=900\text{A}, R_G=0.51\Omega, L_S=40\text{nH}, V_{GE}=-8\text{V}/+15\text{V}, T_j=25^{\circ}\text{C}$		330		ns	
t_r	Rise Time			140		ns	
$t_{d(off)}$	Turn-Off Delay Time			842		ns	
t_f	Fall Time			84		ns	
E_{on}	Turn-On Switching Loss			144		mJ	
E_{off}	Turn-Off Switching Loss			87.8		mJ	
$t_{d(on)}$	Turn-On Delay Time		$V_{CC}=600\text{V}, I_C=900\text{A}, R_G=0.51\Omega, L_S=40\text{nH}, V_{GE}=-8\text{V}/+15\text{V}, T_j=125^{\circ}\text{C}$		373		ns
t_r	Rise Time				155		ns
$t_{d(off)}$	Turn-Off Delay Time				915		ns
t_f	Fall Time				135		ns
E_{on}	Turn-On Switching Loss			186		mJ	
E_{off}	Turn-Off Switching Loss			104		mJ	
$t_{d(on)}$	Turn-On Delay Time	$V_{CC}=600\text{V}, I_C=900\text{A}, R_G=0.51\Omega, L_S=40\text{nH}, V_{GE}=-8\text{V}/+15\text{V}, T_j=175^{\circ}\text{C}$			390		ns
t_r	Rise Time				172		ns
$t_{d(off)}$	Turn-Off Delay Time				950		ns
t_f	Fall Time				162		ns
E_{on}	Turn-On Switching Loss			209		mJ	
E_{off}	Turn-Off Switching Loss			114		mJ	
I_{SC}	SC Data		$t_p \leq 8\mu\text{s}, V_{GE}=15\text{V}, T_j=150^{\circ}\text{C}, V_{CC}=800\text{V}, V_{CEM} \leq 1200\text{V}$		3200		A
			$t_p \leq 6\mu\text{s}, V_{GE}=15\text{V}, T_j=175^{\circ}\text{C}, V_{CC}=800\text{V}, V_{CEM} \leq 1200\text{V}$		3000		A

Diode Characteristics $T_F=25^{\circ}\text{C}$ unless otherwise noted

Symbol	Parameter	Test Conditions	Min.	Typ.	Max.	Units
V_F	Diode Forward Voltage	$I_F=1000\text{A}, V_{GE}=0\text{V}, T_j=25^{\circ}\text{C}$		1.60	2.05	V
		$I_F=1000\text{A}, V_{GE}=0\text{V}, T_j=125^{\circ}\text{C}$		1.70		
		$I_F=1000\text{A}, V_{GE}=0\text{V}, T_j=175^{\circ}\text{C}$		1.60		
Q_r	Recovered Charge			91.0		μC
I_{RM}	Peak Reverse Recovery Current	$V_R=600\text{V}, I_F=900\text{A},$ $-di/dt=4930\text{A}/\mu\text{s}, V_{GE}=-8\text{V},$ $L_S=40\text{nH}, T_j=25^{\circ}\text{C}$		441		A
E_{rec}	Reverse Recovery Energy			26.3		mJ
Q_r	Recovered Charge			141		μC
I_{RM}	Peak Reverse Recovery Current	$V_R=600\text{V}, I_F=900\text{A},$ $-di/dt=4440\text{A}/\mu\text{s}, V_{GE}=-8\text{V},$ $L_S=40\text{nH}, T_j=125^{\circ}\text{C}$		493		A
E_{rec}	Reverse Recovery Energy			42.5		mJ
Q_r	Recovered Charge			174		μC
I_{RM}	Peak Reverse Recovery Current	$V_R=600\text{V}, I_F=900\text{A},$ $-di/dt=4160\text{A}/\mu\text{s}, V_{GE}=-8\text{V},$ $L_S=40\text{nH}, T_j=175^{\circ}\text{C}$		536		A
E_{rec}	Reverse Recovery Energy			52.4		mJ

NTC Characteristics $T_F=25^{\circ}\text{C}$ unless otherwise noted

Symbol	Parameter	Test Conditions	Min.	Typ.	Max.	Unit
R_{25}	Rated Resistance			5.0		$\text{k}\Omega$
$\Delta R/R$	Deviation of R_{100}	$T_C=100^{\circ}\text{C}, R_{100}=493.3\Omega$	-5		5	%
P_{25}	Power Dissipation				20.0	mW
$B_{25/50}$	B-value	$R_2=R_{25}\exp[B_{25/50}(1/T_2-1/(298.15\text{K}))]$		3375		K
$B_{25/80}$	B-value	$R_2=R_{25}\exp[B_{25/80}(1/T_2-1/(298.15\text{K}))]$		3411		K
$B_{25/100}$	B-value	$R_2=R_{25}\exp[B_{25/100}(1/T_2-1/(298.15\text{K}))]$		3433		K

Module Characteristics $T_F=25^{\circ}\text{C}$ unless otherwise noted

Symbol	Parameter	Min.	Typ.	Max.	Unit
L_{CE}	Stray Inductance		20		nH
$R_{CC'+EE'}$	Module Lead Resistance, Terminal to Chip		0.80		m Ω
R_{thJF}	Junction-to-Cooling Fluid (per IGBT) Junction-to-Cooling Fluid (per Diode) $\Delta V/\Delta t=10.0\text{dm}^3/\text{min}, T_F=75^{\circ}\text{C}$			0.066 0.092	K/W
M	Terminal Connection Torque, Screw M6 Mounting Torque, Screw M5	3.0 3.0		6.0 6.0	N.m
G	Weight of Module		400		g

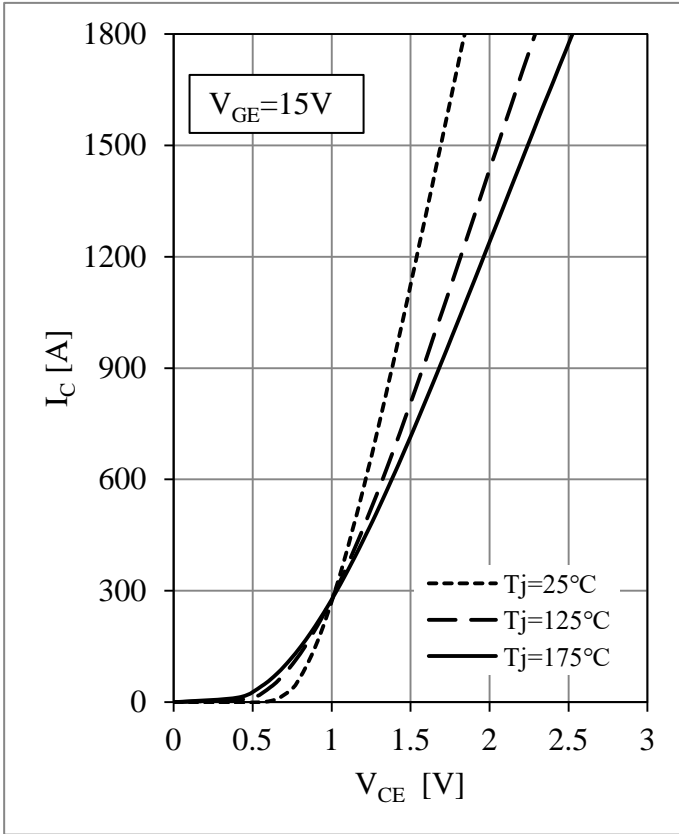

Fig 1. IGBT Output Characteristics

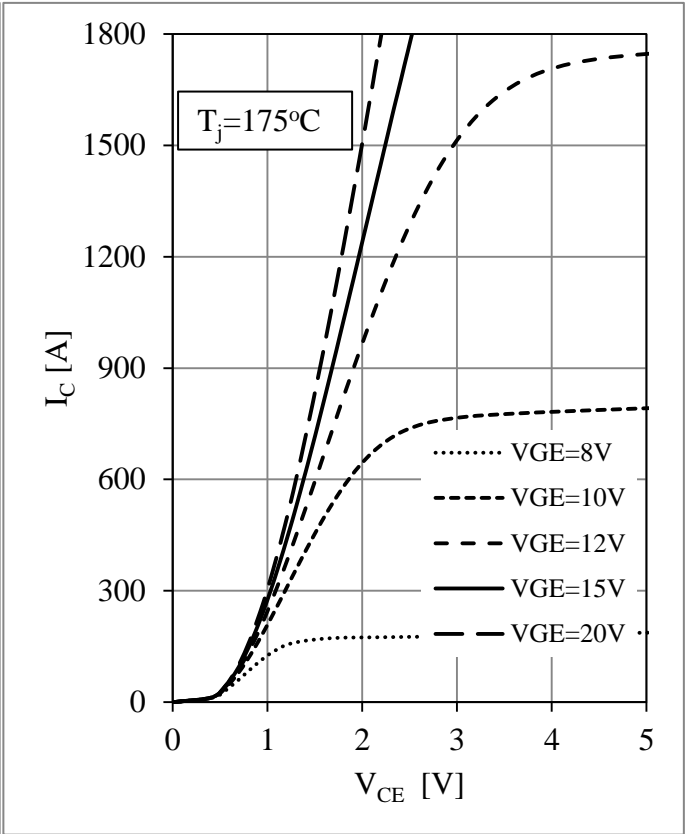

Fig 2. IGBT Transfer Characteristics

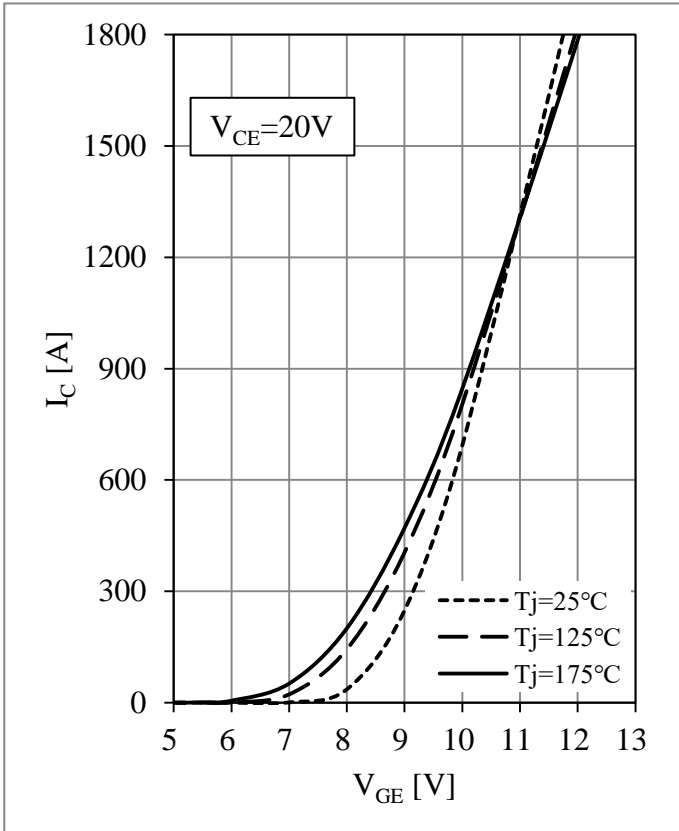

Fig 3. IGBT Transfer Characteristics

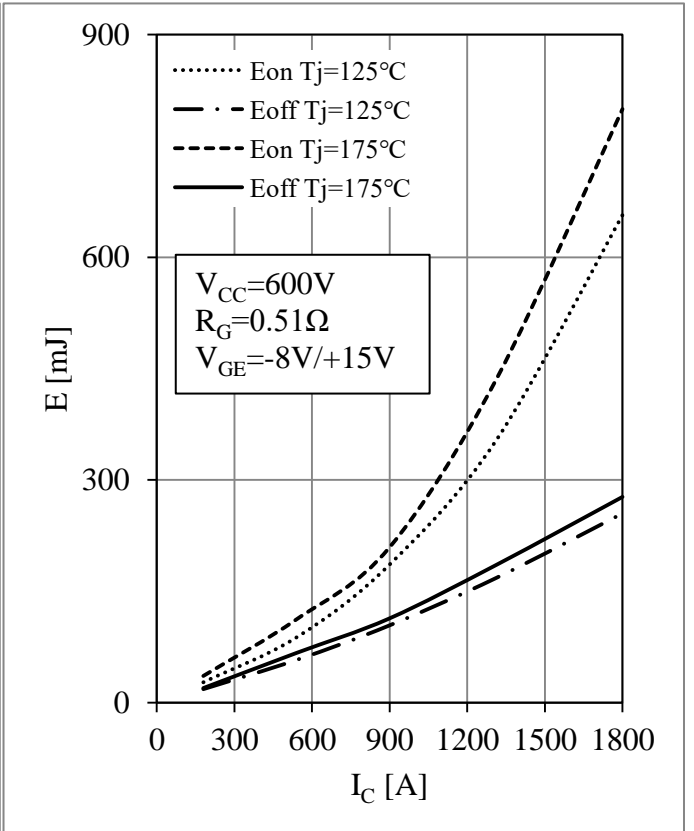

Fig 4. IGBT Switching Loss vs. I_c

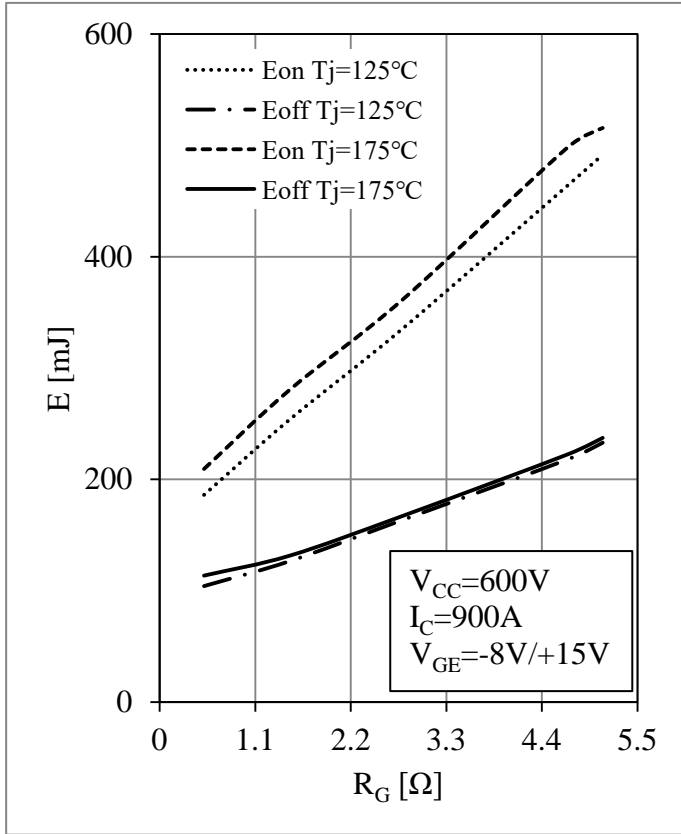

Fig 5. IGBT Switching Loss vs. R_G

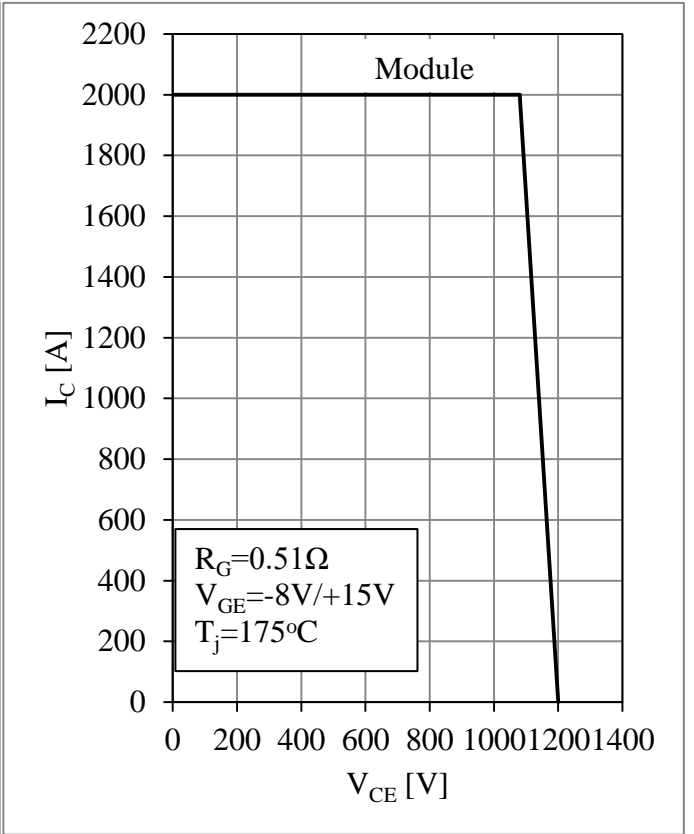

Fig 6. RBSOA

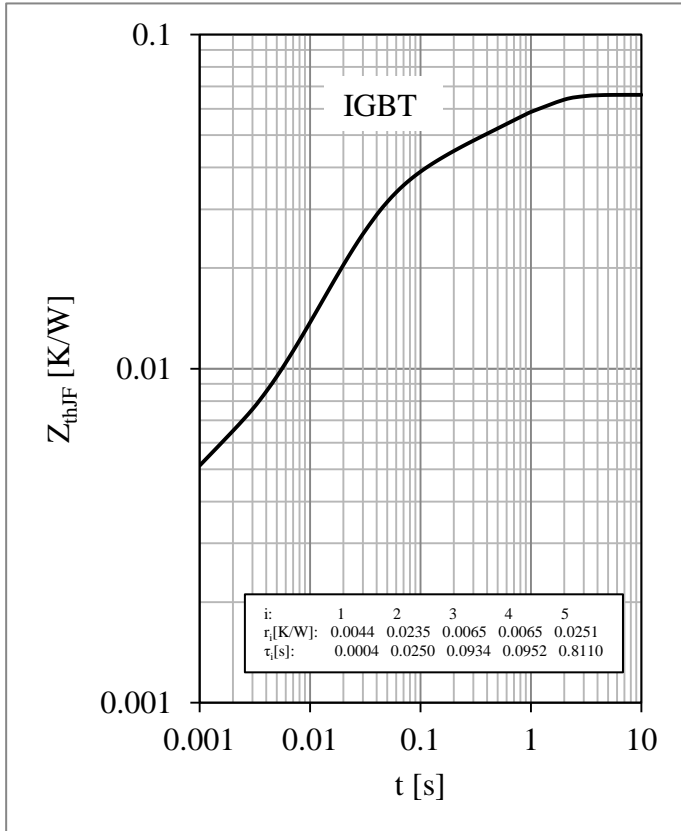

Fig 7. IGBT Transient Thermal Impedance

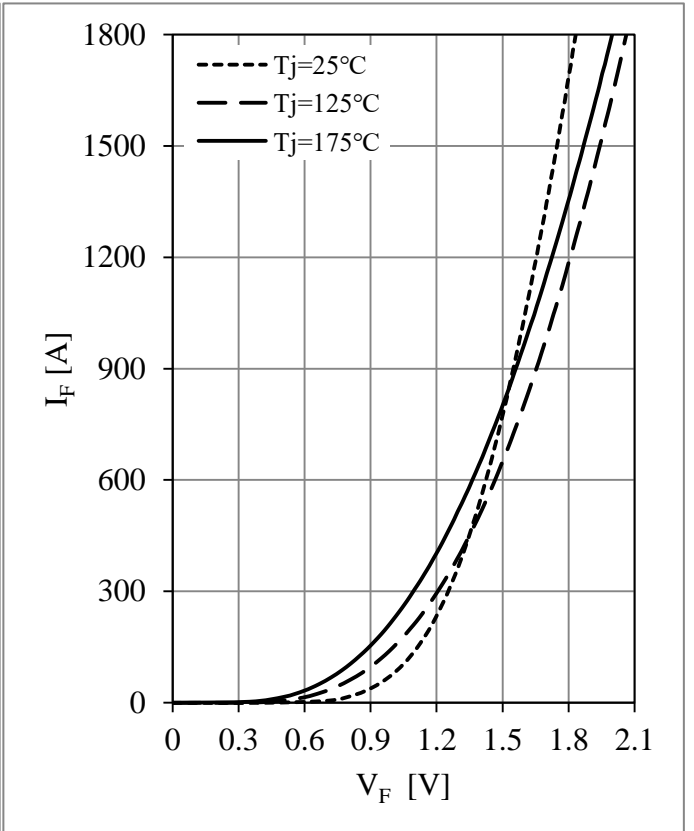

Fig 8. Diode Forward Characteristics

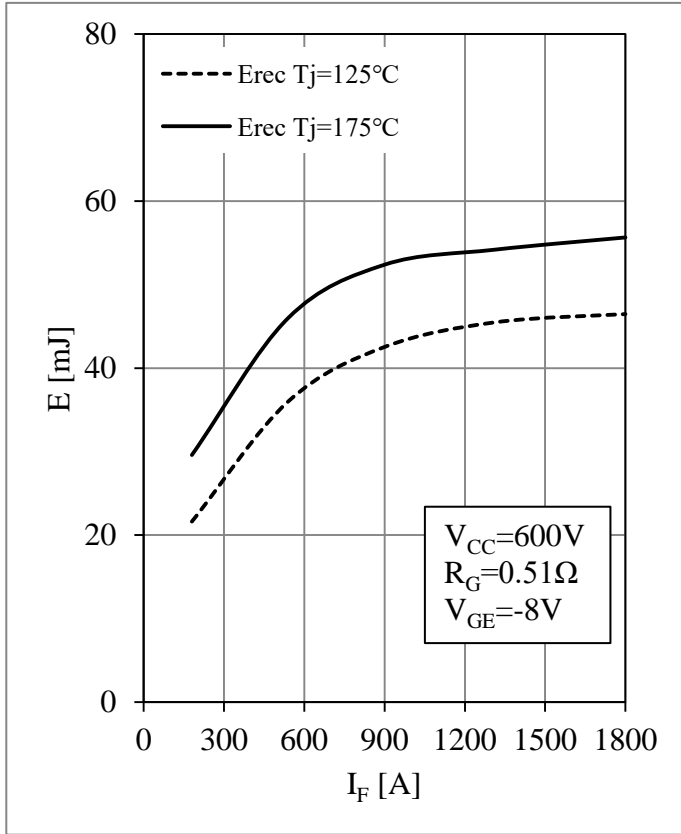

Fig 9. Diode Switching Loss vs. I_F

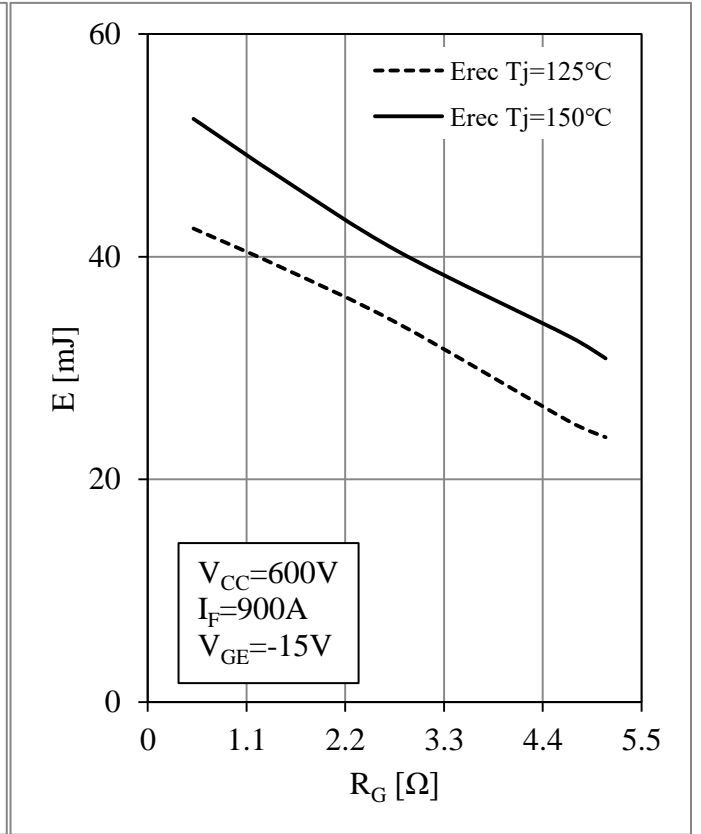

Fig 10. Diode Switching Loss vs. R_G

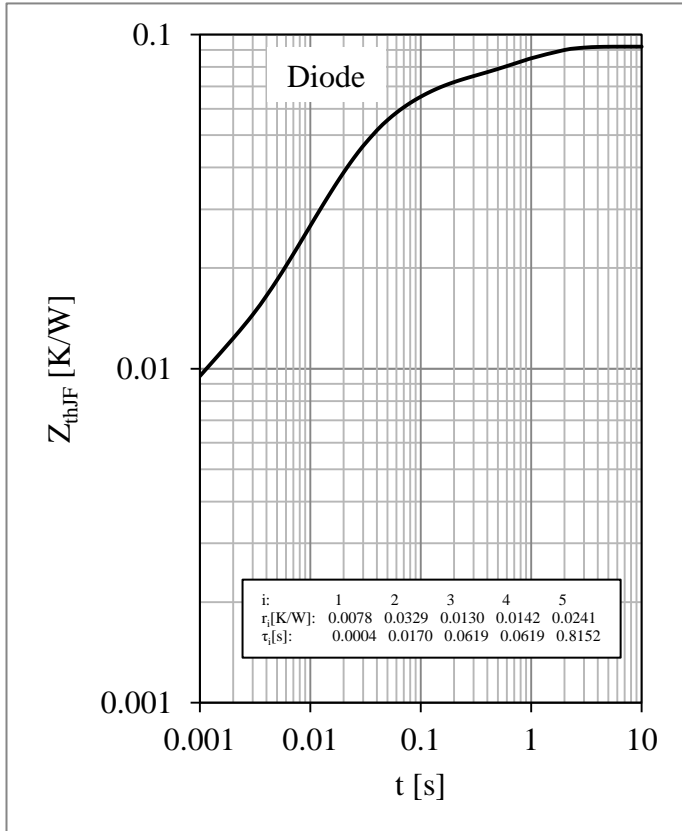

Fig 11. Diode Transient Thermal Impedance

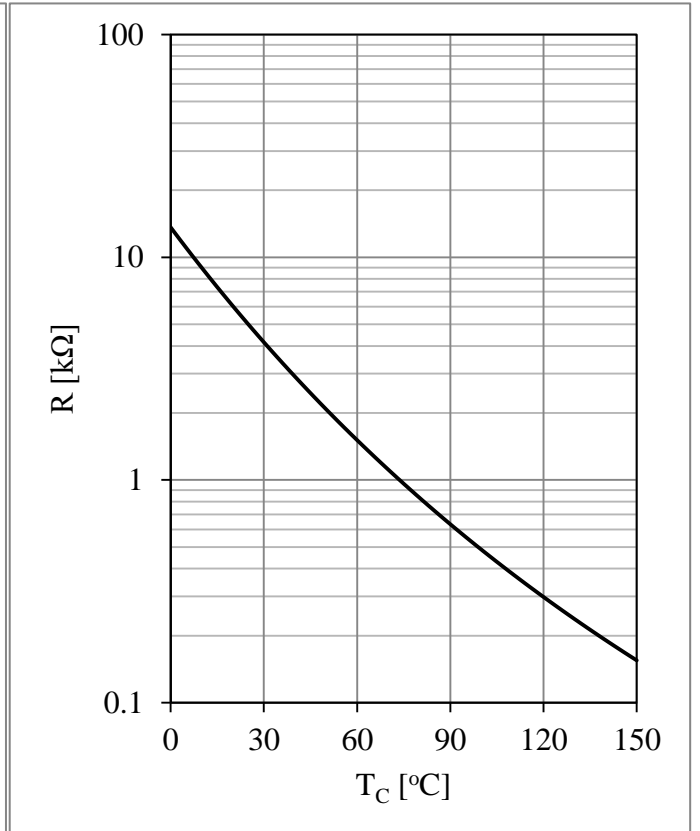

Fig12. NTC Temperature Characteristic

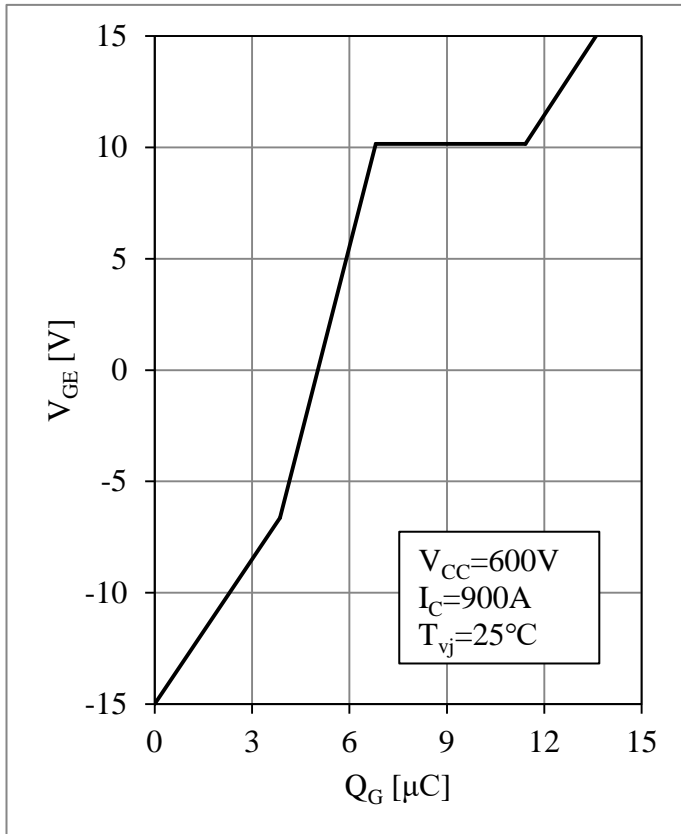
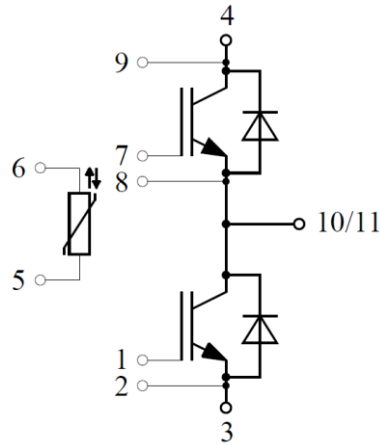

Fig 13. IGBT Gate Charge Characteristic

Circuit Schematic



Package Dimensions

Dimensions in Millimeters

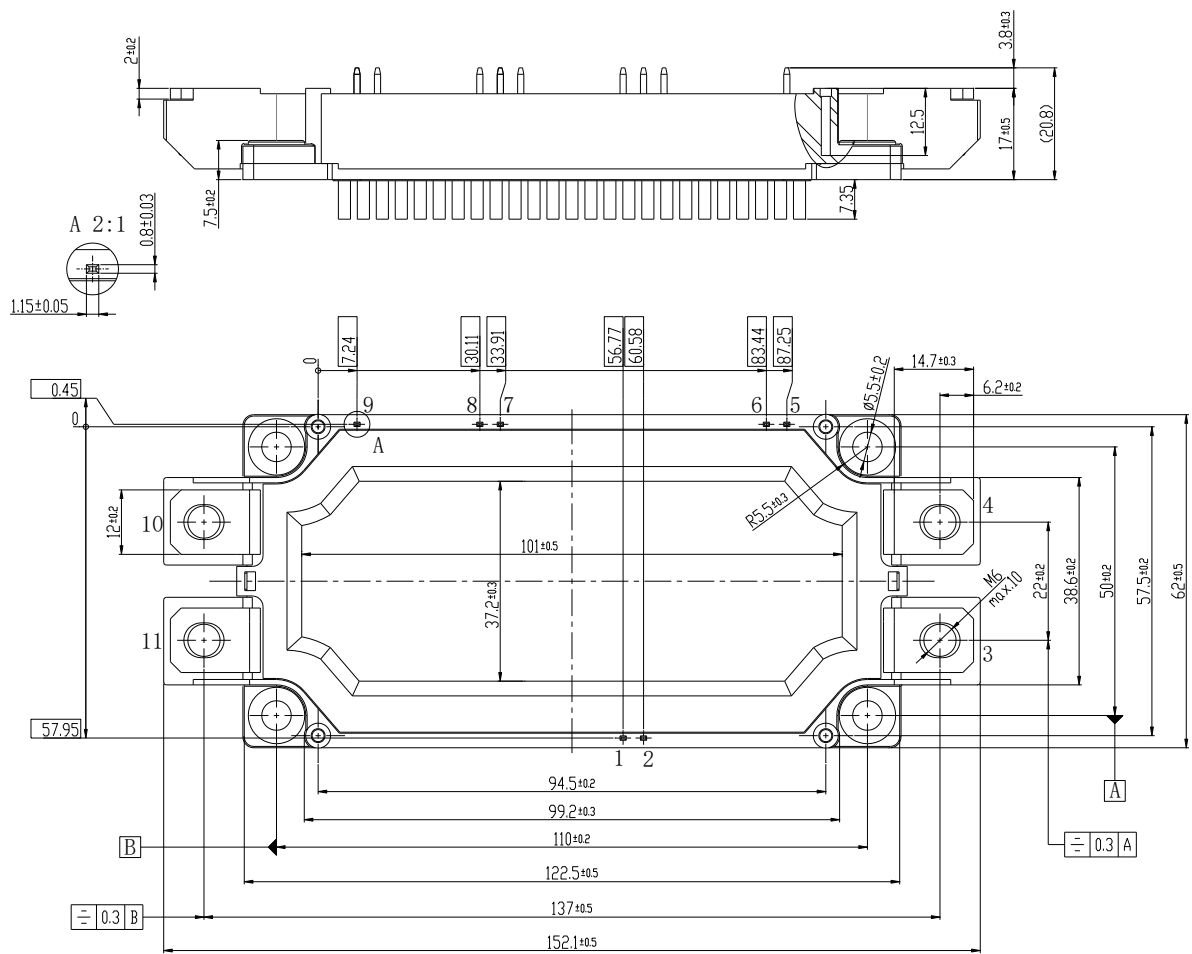

 = all dimension with a tolerance of ± 0.5

Terms and Conditions of Usage

The data contained in this product datasheet is exclusively intended for technically trained staff. you and your technical departments will have to evaluate the suitability of the product for the intended application and the completeness of the product data with respect to such application.

This product data sheet is describing the characteristics of this product for which a warranty is granted. Any such warranty is granted exclusively pursuant the terms and conditions of the supply agreement. There will be no guarantee of any kind for the product and its characteristics.

Should you require product information in excess of the data given in this product data sheet or which concerns the specific application of our product, please contact the sales office, which is responsible for you (see www.powersemi.cc), For those that are specifically interested we may provide application notes.

Due to technical requirements our product may contain dangerous substances. For information on the types in question please contact the sales office, which is responsible for you.

Should you intend to use the Product in aviation applications, in health or live endangering or life support applications, please notify.

If and to the extent necessary, please forward equivalent notices to your customers.
Changes of this product data sheet are reserved.