

# DOSEMI

# IGBT

## DG30X07T2

### 650V/30A IGBT with Diode

### General Description

DOSEMI IGBT Power Discrete provides ultra low conduction loss as well as low switching loss. They are designed for the applications such as general inverters and UPS.

### Features

- Low  $V_{CE(sat)}$  Fast IGBT technology
- 6 $\mu$ s short circuit capability
- Low switching loss
- Maximum junction temperature 175°C
- $V_{CE(sat)}$  with positive temperature coefficient
- Fast & soft reverse recovery anti-parallel FWD
- Lead free package

### Typical Applications

- Inverter for motor drive
- AC and DC servo drive amplifier
- Uninterruptible power supply

### Equivalent Circuit Schematic

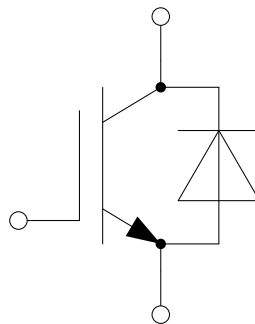

**Absolute Maximum Ratings**  $T_C=25^{\circ}\text{C}$  unless otherwise noted**IGBT**

Symbol	Description	Values	Unit
$V_{CES}$	Collector-Emitter Voltage	650	V
$V_{GES}$	Gate-Emitter Voltage	+20	V
$I_C$	Collector Current @ $T_C=25^{\circ}\text{C}$	60	A
	@ $T_C=125^{\circ}\text{C}$	30	A
$I_{CM}$	Pulsed Collector Current $t_p$ limited by $T_{jmax}$	90	A
$P_D$	Maximum Power Dissipation @ $T_j=175^{\circ}\text{C}$	208	W

**Diode**

Symbol	Description	Values	Unit
$V_{RRM}$	Repetitive Peak Reverse Voltage	650	V
$I_F$	Diode Continuous Forward Current	30	A
$I_{FM}$	Diode Maximum Forward Current $t_p$ limited by $T_{jmax}$	90	A

**Discrete**

Symbol	Description	Values	Unit
$T_{jop}$	Operating Junction Temperature	-40 to +175	$^{\circ}\text{C}$
$T_{STG}$	Storage Temperature Range	-55 to +150	$^{\circ}\text{C}$
$T_S$	Soldering Temperature, 1.6mm from case for 10s	260	$^{\circ}\text{C}$
M	Mounting Torque, Screw M3	0.6	N.m

**IGBT Characteristics**  $T_c=25^\circ\text{C}$  unless otherwise noted

Symbol	Parameter	Test Conditions	Min.	Typ.	Max.	Unit
$V_{CE(sat)}$	Collector to Emitter Saturation Voltage	$I_C=30\text{A}, V_{GE}=15\text{V}, T_j=25^\circ\text{C}$		1.50	1.95	V
		$I_C=30\text{A}, V_{GE}=15\text{V}, T_j=150^\circ\text{C}$		1.80		
		$I_C=30\text{A}, V_{GE}=15\text{V}, T_j=175^\circ\text{C}$		1.80		
$V_{GE(th)}$	Gate-Emitter Threshold Voltage	$I_C=0.48\text{mA}, V_{CE}=V_{GE}, T_j=25^\circ\text{C}$	5.1	5.8	6.5	V
$I_{CES}$	Collector Cut-Off Current	$V_{CE}=V_{CES}, V_{GE}=0\text{V}, T_j=25^\circ\text{C}$			100	$\mu\text{A}$
$I_{GES}$	Gate-Emitter Leakage Current	$V_{GE}=V_{GES}, V_{CE}=0\text{V}, T_j=25^\circ\text{C}$			100	nA
$R_{Gint}$	Internal Gate Resistance			0		$\Omega$
$C_{ies}$	Input Capacitance	$V_{CE}=25\text{V}, f=100\text{kHz}, V_{GE}=0\text{V}$		3.35		nF
$C_{res}$	Reverse Transfer Capacitance			0.08		nF
$Q_G$	Gate Charge	$V_{GE}=-15\dots+15\text{V}$		0.22		$\mu\text{C}$
$t_{d(on)}$	Turn-On Delay Time	$V_{CC}=400\text{V}, I_C=30\text{A}, R_G=15\Omega, V_{GE}=\pm 15\text{V}, T_j=25^\circ\text{C}$		34		ns
$t_r$	Rise Time			70		ns
$t_{d(off)}$	Turn-Off Delay Time			108		ns
$t_f$	Fall Time			145		ns
$E_{on}$	Turn-On Switching Loss			1.34		mJ
$E_{off}$	Turn-Off Switching Loss			0.65		mJ
$t_{d(on)}$	Turn-On Delay Time	$V_{CC}=400\text{V}, I_C=30\text{A}, R_G=15\Omega, V_{GE}=\pm 15\text{V}, T_j=150^\circ\text{C}$		31		ns
$t_r$	Rise Time			68		ns
$t_{d(off)}$	Turn-Off Delay Time			108		ns
$t_f$	Fall Time			193		ns
$E_{on}$	Turn-On Switching Loss			1.48		mJ
$E_{off}$	Turn-Off Switching Loss			0.83		mJ
$t_{d(on)}$	Turn-On Delay Time	$V_{CC}=400\text{V}, I_C=30\text{A}, R_G=15\Omega, V_{GE}=\pm 15\text{V}, T_j=175^\circ\text{C}$		32		ns
$t_r$	Rise Time			68		ns
$t_{d(off)}$	Turn-Off Delay Time			113		ns
$t_f$	Fall Time			193		ns
$E_{on}$	Turn-On Switching Loss			1.67		mJ
$E_{off}$	Turn-Off Switching Loss			0.86		mJ
$I_{SC}$	SC Data	$t_p \leq 6\mu\text{s}, V_{GE}=15\text{V}, T_j=150^\circ\text{C}, V_{CC}=400\text{V}, V_{CEM} \leq 650\text{V}$		200		A

**Diode Characteristics**  $T_C=25^\circ\text{C}$  unless otherwise noted

Symbol	Parameter	Test Conditions	Min.	Typ.	Max.	Unit
$V_F$	Diode Forward Voltage	$I_F=30\text{A}, V_{GE}=0\text{V}, T_j=25^\circ\text{C}$		1.70	2.15	V
		$I_F=30\text{A}, V_{GE}=0\text{V}, T_j=150^\circ\text{C}$		1.70		
		$I_F=30\text{A}, V_{GE}=0\text{V}, T_j=175^\circ\text{C}$		1.65		
$Q_r$	Recovered Charge	$V_R=400\text{V}, I_F=30\text{A},$ $-di/dt=317\text{A}/\mu\text{s}, V_{GE}=-15\text{V}$ $T_j=25^\circ\text{C}$		0.60		$\mu\text{C}$
$I_{RM}$	Peak Reverse Recovery Current			7.20		A
$E_{rec}$	Reverse Recovery Energy			0.12		mJ
$Q_r$	Recovered Charge	$V_R=400\text{V}, I_F=30\text{A},$ $-di/dt=315\text{A}/\mu\text{s}, V_{GE}=-15\text{V}$ $T_j=150^\circ\text{C}$		1.15		$\mu\text{C}$
$I_{RM}$	Peak Reverse Recovery Current			9.90		A
$E_{rec}$	Reverse Recovery Energy			0.25		mJ
$Q_r$	Recovered Charge	$V_R=400\text{V}, I_F=30\text{A},$ $-di/dt=311\text{A}/\mu\text{s}, V_{GE}=-15\text{V}$ $T_j=175^\circ\text{C}$		1.39		$\mu\text{C}$
$I_{RM}$	Peak Reverse Recovery Current			11.4		A
$E_{rec}$	Reverse Recovery Energy			0.30		mJ

**Discrete Characteristics**  $T_C=25^\circ\text{C}$  unless otherwise noted

Symbol	Parameter	Min.	Typ.	Max.	Unit
$R_{thJC}$	Junction-to-Case (per IGBT)			0.720	K/W
	Junction-to-Case (per Diode)			1.050	
$R_{thJA}$	Junction-to-Ambient		40		K/W

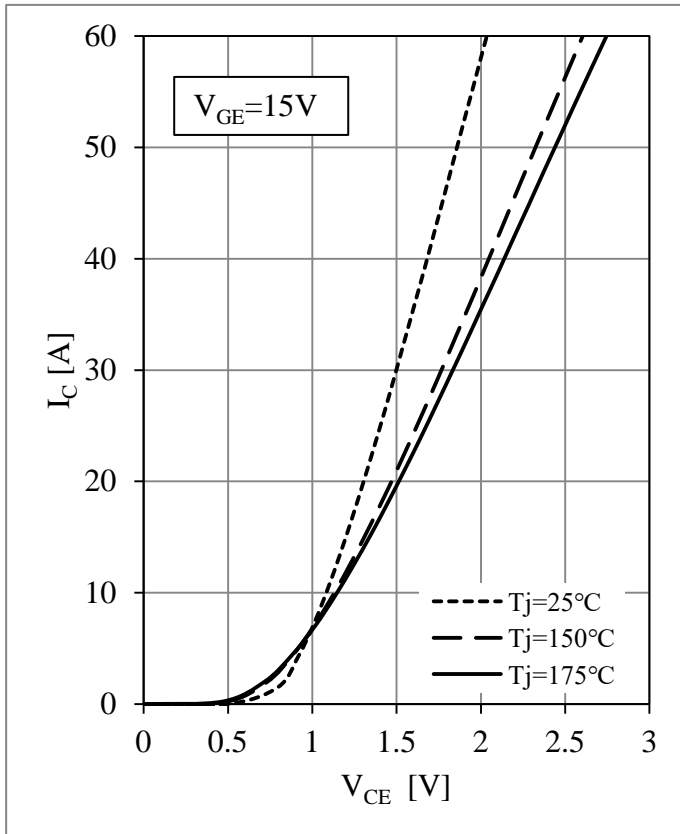

Fig 1. IGBT-inverter Output Characteristics

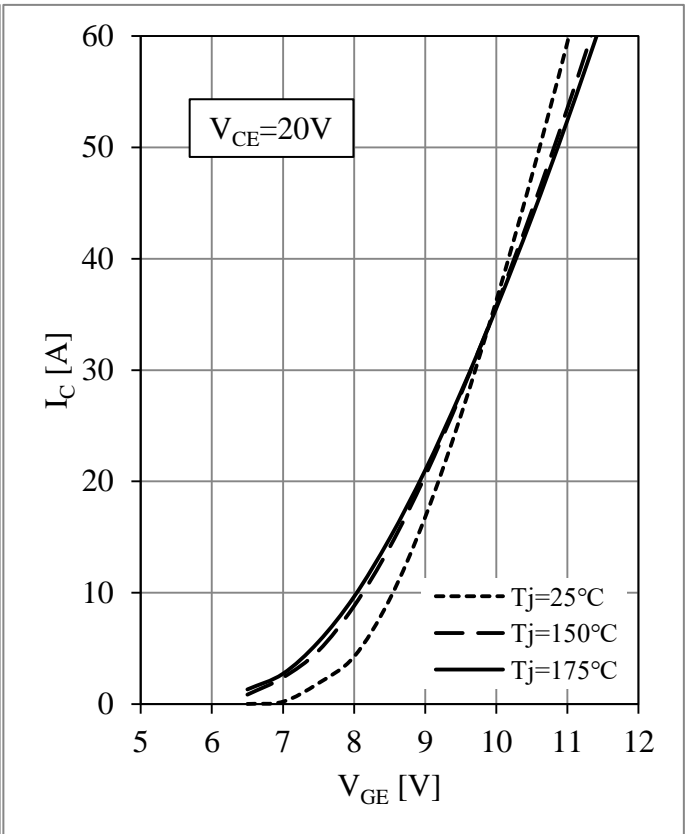

Fig 2. IGBT-inverter Transfer Characteristics

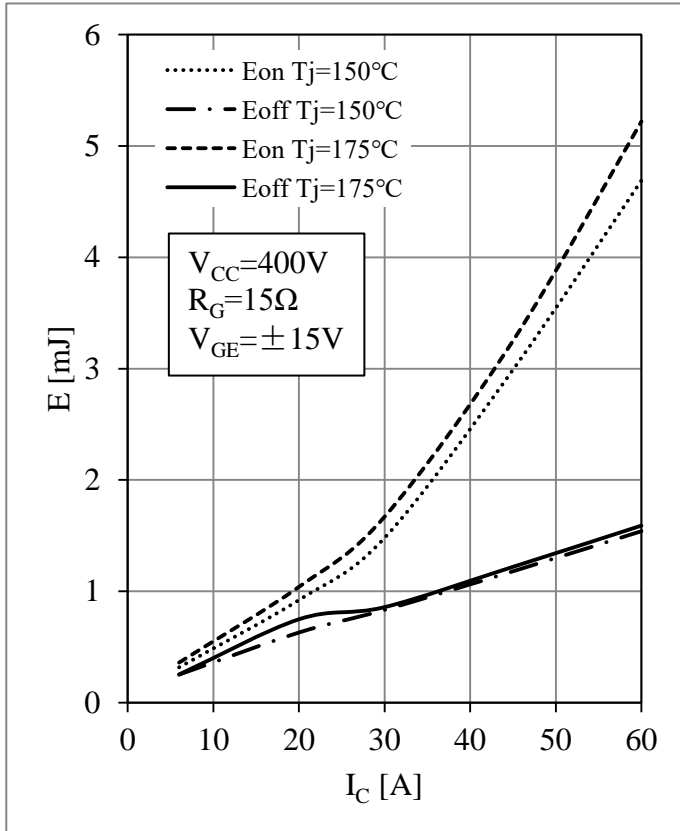

Fig 3. IGBT-inverter Switching Loss vs.  $I_C$

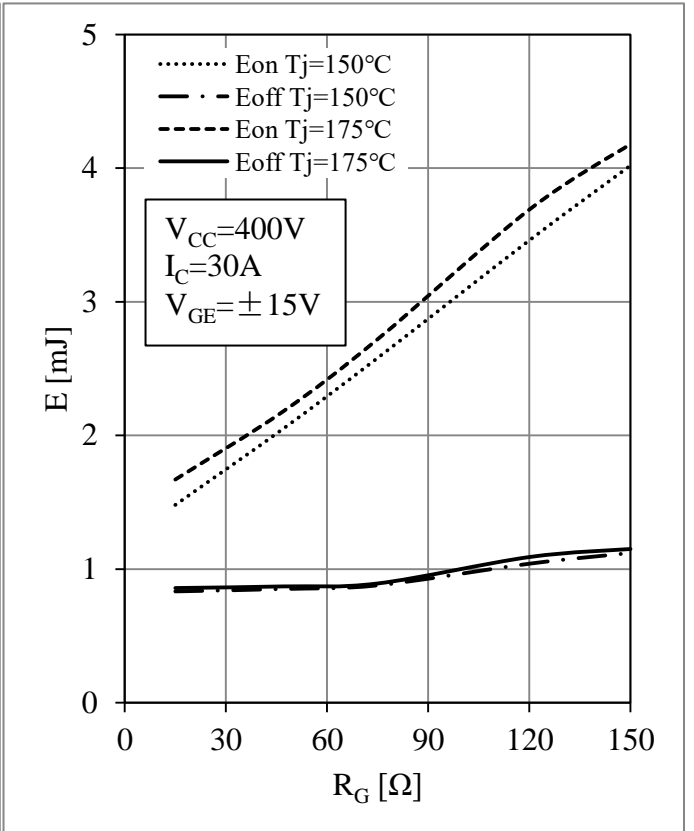

Fig 4. IGBT-inverter Switching Loss vs.  $R_G$

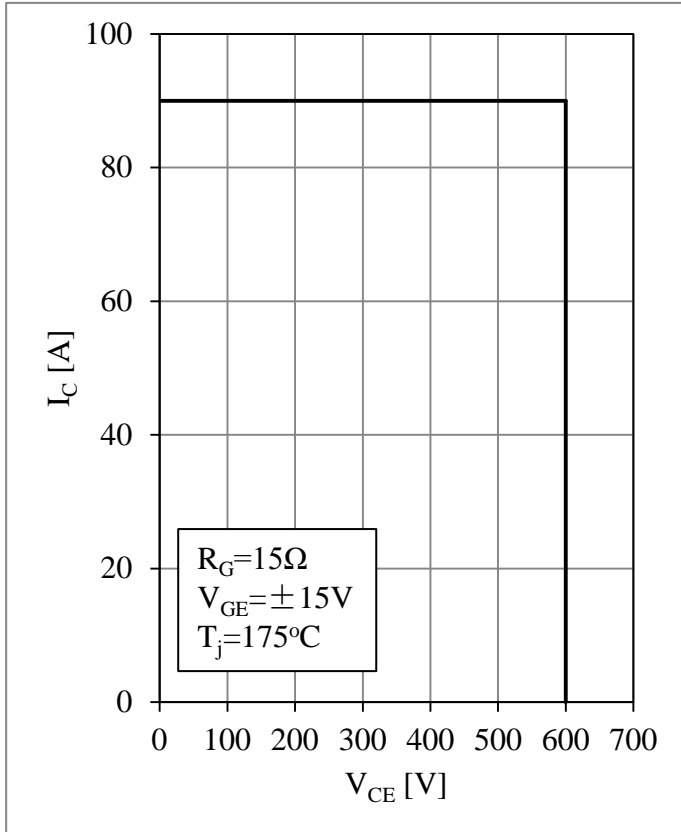

Fig 5. IGBT-inverter RBSOA

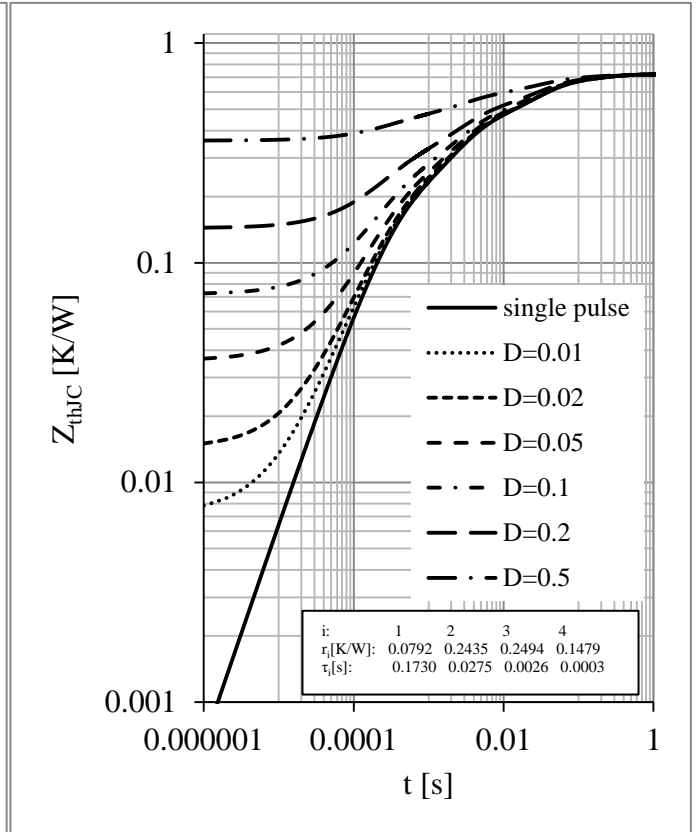

Fig 6. IGBT-inverter Transient Thermal Impedance

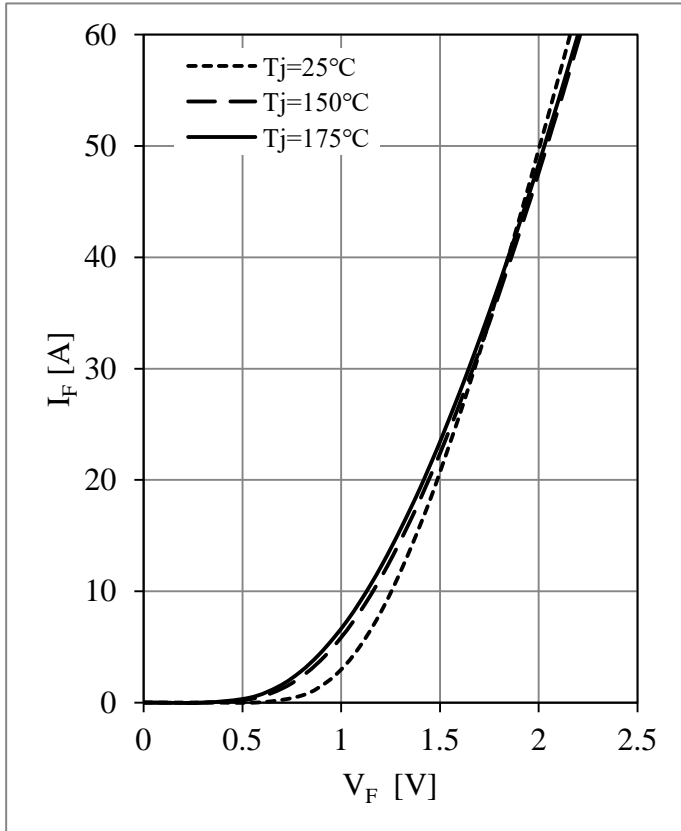

Fig 7. Diode-inverter Forward Characteristics

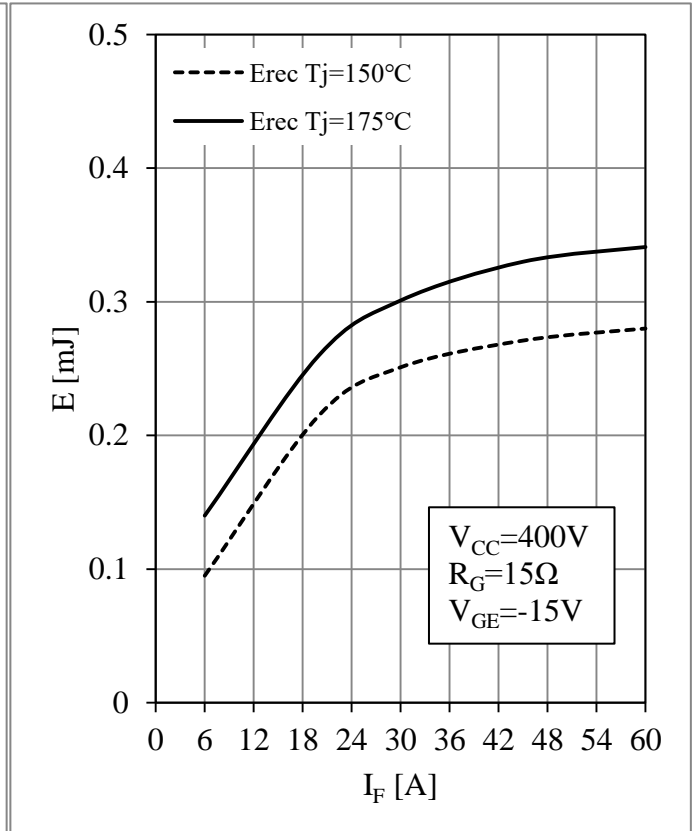

Fig 8. Diode-inverter Switching Loss vs.  $I_F$

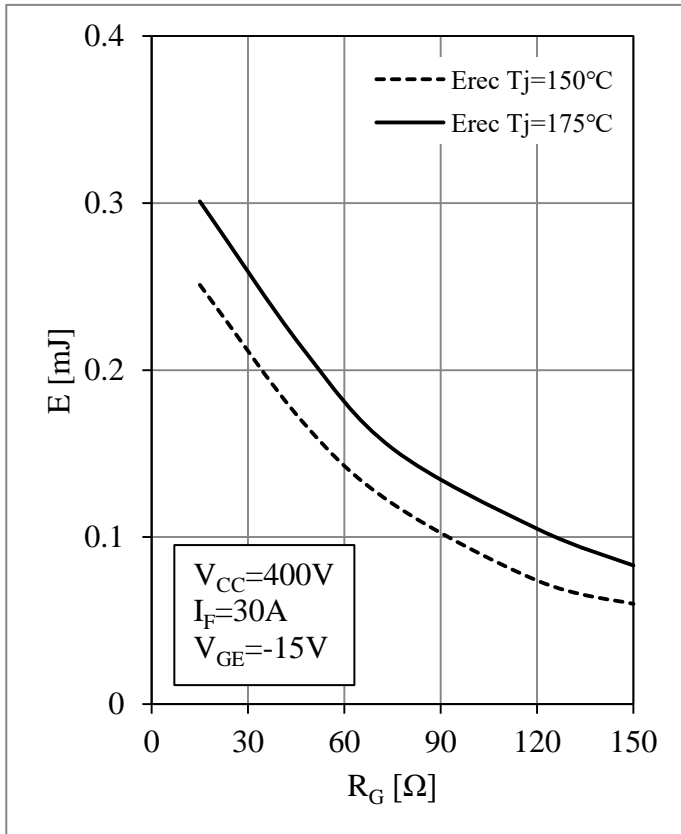

Fig 9. Diode-inverter Switching Loss vs.  $R_G$

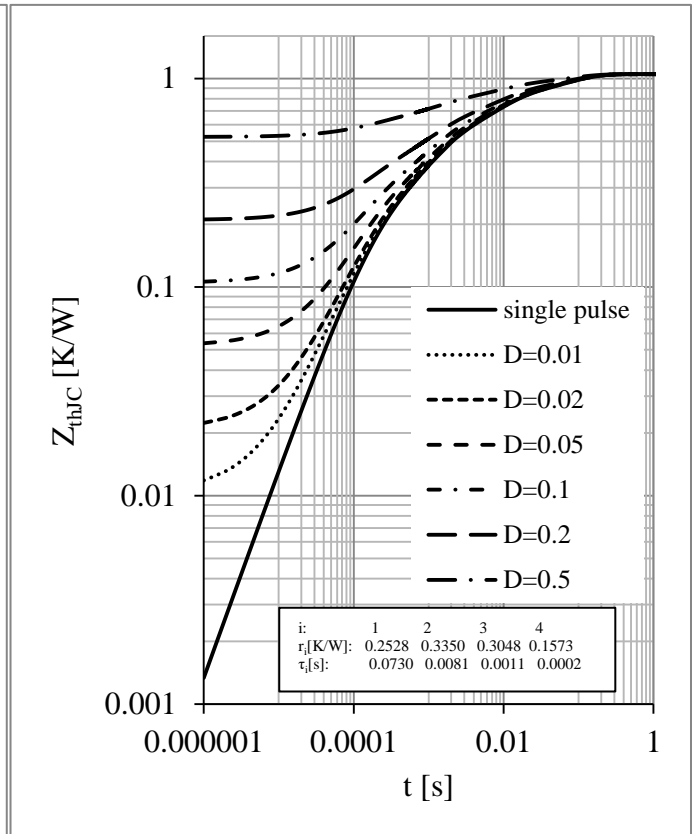
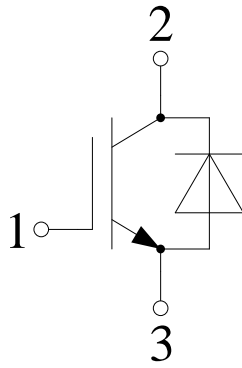

Fig 10. Diode-inverter Transient Thermal Impedance

### Circuit Schematic



### Package Dimensions

Dimensions in Millimeters

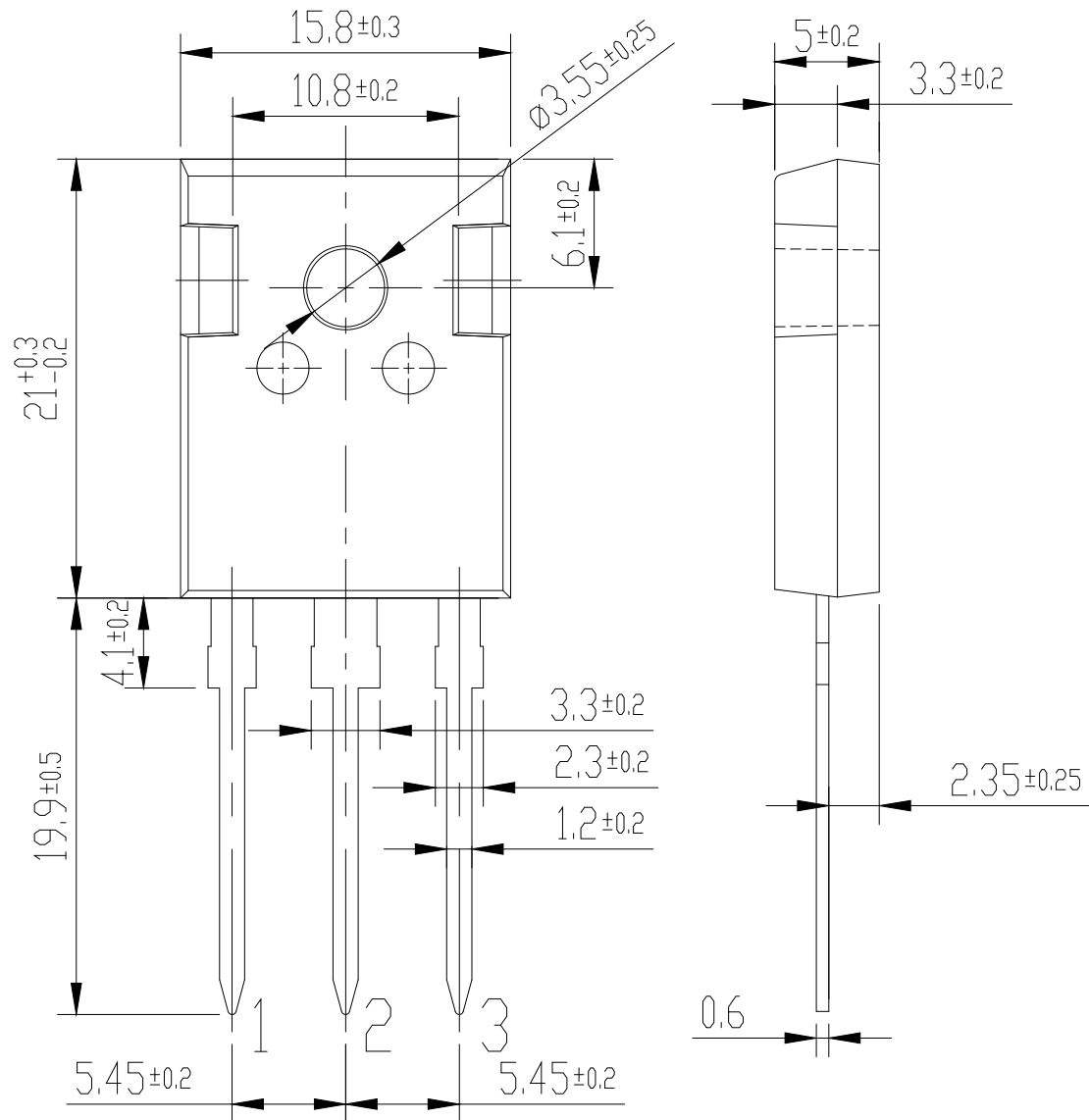



## Terms and Conditions of Usage

The data contained in this product datasheet is exclusively intended for technically trained staff. you and your technical departments will have to evaluate the suitability of the product for the intended application and the completeness of the product data with respect to such application.

This product data sheet is describing the characteristics of this product for which a warranty is granted. Any such warranty is granted exclusively pursuant the terms and conditions of the supply agreement. There will be no guarantee of any kind for the product and its characteristics.

Should you require product information in excess of the data given in this product data sheet or which concerns the specific application of our product, please contact the sales office, which is responsible for you (see [www.powersemi.cc](http://www.powersemi.cc)), For those that are specifically interested we may provide application notes.

Due to technical requirements our product may contain dangerous substances. For information on the types in question please contact the sales office, which is responsible for you.

Should you intend to use the Product in aviation applications, in health or live endangering or life support applications, please notify.

If and to the extent necessary, please forward equivalent notices to your customers.  
Changes of this product data sheet are reserved.