

# STARPOWER

SEMICONDUCTOR

**IGBT**

## GD300HFY65C2S

**650V/300A 2 in one-package**

### General Description

STARPOWER IGBT Power Module provides ultra low conduction loss as well as short circuit ruggedness. They are designed for the applications such as general inverters and UPS.

### Features

- Low  $V_{CE(sat)}$  Trench IGBT technology
- 6 $\mu$ s short circuit capability
- $V_{CE(sat)}$  with positive temperature coefficient
- Maximum junction temperature 175°C
- Low inductance case
- Fast & soft reverse recovery anti-parallel FWD
- Isolated copper baseplate using DBC technology



### Typical Applications

- Automotive application
- Hybrid and electric vehicle
- Inverter for motor drive

### Equivalent Circuit Schematic

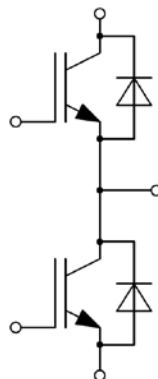

**Absolute Maximum Ratings**  $T_C=25^{\circ}\text{C}$  unless otherwise noted**IGBT**

Symbol	Description	Value	Unit
$V_{CES}$	Collector-Emitter Voltage	650	V
$V_{GES}$	Gate-Emitter Voltage	$\pm 20$	V
$I_C$	Collector Current @ $T_C=25^{\circ}\text{C}$	343	A
	@ $T_C=55^{\circ}\text{C}$	300	
$I_{CM}$	Pulsed Collector Current $t_p=1\text{ms}$	600	A
$P_D$	Maximum Power Dissipation @ $T_j=175^{\circ}\text{C}$	819	W

**Diode**

Symbol	Description	Value	Unit
$V_{RRM}$	Repetitive Peak Reverse Voltage	650	V
$I_F$	Diode Continuous Forward Current	300	A
$I_{FM}$	Diode Maximum Forward Current $t_p=1\text{ms}$	600	A

**Module**

Symbol	Description	Value	Unit
$T_{jmax}$	Maximum Junction Temperature	175	$^{\circ}\text{C}$
$T_{jop}$	Operating Junction Temperature	-40 to +150	$^{\circ}\text{C}$
$T_{STG}$	Storage Temperature Range	-40 to +125	$^{\circ}\text{C}$
$V_{ISO}$	Isolation Voltage RMS, $f=50\text{Hz}$ , $t=1\text{min}$	4000	V

**IGBT Characteristics**  $T_C=25^\circ\text{C}$  unless otherwise noted

Symbol	Parameter	Test Conditions	Min.	Typ.	Max.	Unit
$V_{CE(sat)}$	Collector to Emitter Saturation Voltage	$I_C=300\text{A}, V_{GE}=15\text{V}, T_j=25^\circ\text{C}$		1.45	1.90	V
		$I_C=300\text{A}, V_{GE}=15\text{V}, T_j=125^\circ\text{C}$		1.60		
		$I_C=300\text{A}, V_{GE}=15\text{V}, T_j=150^\circ\text{C}$		1.70		
$V_{GE(th)}$	Gate-Emitter Threshold Voltage	$I_C=4.8\text{mA}, V_{CE}=V_{GE}, T_j=25^\circ\text{C}$	5.1	5.8	6.4	V
$I_{CES}$	Collector Cut-Off Current	$V_{CE}=V_{CES}, V_{GE}=0\text{V}, T_j=25^\circ\text{C}$			5.0	mA
$I_{GES}$	Gate-Emitter Leakage Current	$V_{GE}=V_{GES}, V_{CE}=0\text{V}, T_j=25^\circ\text{C}$			400	nA
$t_{d(on)}$	Turn-On Delay Time	$V_{CC}=300\text{V}, I_C=300\text{A}, R_G=2.4\Omega, V_{GE}=\pm 15\text{V}, T_j=25^\circ\text{C}$		89		ns
$t_r$	Rise Time			39		ns
$t_{d(off)}$	Turn-Off Delay Time			391		ns
$t_f$	Fall Time			39		ns
$E_{on}$	Turn-On Switching Loss			1.69		mJ
$E_{off}$	Turn-Off Switching Loss			7.87		mJ
$t_{d(on)}$	Turn-On Delay Time	$V_{CC}=300\text{V}, I_C=300\text{A}, R_G=2.4\Omega, V_{GE}=\pm 15\text{V}, T_j=125^\circ\text{C}$		95		ns
$t_r$	Rise Time			49		ns
$t_{d(off)}$	Turn-Off Delay Time			416		ns
$t_f$	Fall Time			55		ns
$E_{on}$	Turn-On Switching Loss			2.40		mJ
$E_{off}$	Turn-Off Switching Loss			9.68		mJ
$t_{d(on)}$	Turn-On Delay Time	$V_{CC}=300\text{V}, I_C=300\text{A}, R_G=2.4\Omega, V_{GE}=\pm 15\text{V}, T_j=150^\circ\text{C}$		103		ns
$t_r$	Rise Time			49		ns
$t_{d(off)}$	Turn-Off Delay Time			425		ns
$t_f$	Fall Time			55		ns
$E_{on}$	Turn-On Switching Loss			2.56		mJ
$E_{off}$	Turn-Off Switching Loss			10.0		mJ
$I_{SC}$	SC Data	$t_p \leq 6\mu\text{s}, V_{GE}=15\text{V}, T_j=150^\circ\text{C}, V_{CC}=360\text{V}, V_{CEM} \leq 650\text{V}$		1500		A

**Diode Characteristics**  $T_C=25^\circ\text{C}$  unless otherwise noted

Symbol	Parameter	Test Conditions	Min.	Typ.	Max.	Unit
$V_F$	Diode Forward Voltage	$I_F=300\text{A}, V_{GE}=0\text{V}, T_j=25^\circ\text{C}$		1.55	2.00	V
		$I_F=300\text{A}, V_{GE}=0\text{V}, T_j=125^\circ\text{C}$		1.50		
		$I_F=300\text{A}, V_{GE}=0\text{V}, T_j=150^\circ\text{C}$		1.45		
$Q_r$	Recovered Charge	$V_R=300\text{V}, I_F=300\text{A},$ $-di/dt=7150\text{A}/\mu\text{s}, V_{GE}=-15\text{V}$ $T_j=25^\circ\text{C}$		14.2		$\mu\text{C}$
$I_{RM}$	Peak Reverse Recovery Current			208		A
$E_{rec}$	Reverse Recovery Energy			3.75		mJ
$Q_r$	Recovered Charge	$V_R=300\text{V}, I_F=300\text{A},$ $-di/dt=7150\text{A}/\mu\text{s}, V_{GE}=-15\text{V}$ $T_j=125^\circ\text{C}$		26.5		$\mu\text{C}$
$I_{RM}$	Peak Reverse Recovery Current			259		A
$E_{rec}$	Reverse Recovery Energy			6.81		mJ
$Q_r$	Recovered Charge	$V_R=300\text{V}, I_F=300\text{A},$ $-di/dt=7150\text{A}/\mu\text{s}, V_{GE}=-15\text{V}$ $T_j=150^\circ\text{C}$		30.7		$\mu\text{C}$
$I_{RM}$	Peak Reverse Recovery Current			274		A
$E_{rec}$	Reverse Recovery Energy			7.70		mJ

**Module Characteristics**  $T_C=25^\circ\text{C}$  unless otherwise noted

Symbol	Parameter	Min.	Typ.	Max.	Unit
$R_{thJC}$	Junction-to-Case (per IGBT)			0.183	K/W
	Junction-to-Case (per Diode)			0.297	
$R_{thCH}$	Case-to-Heatsink (per IGBT)		0.032		K/W
	Case-to-Heatsink (per Diode)		0.052		
	Case-to-Heatsink (per Module)		0.010		
M	Terminal Connection Torque, Screw M5	2.5		5.0	N.m
	Mounting Torque, Screw M6	3.0		5.0	
G	Weight of Module		300		g

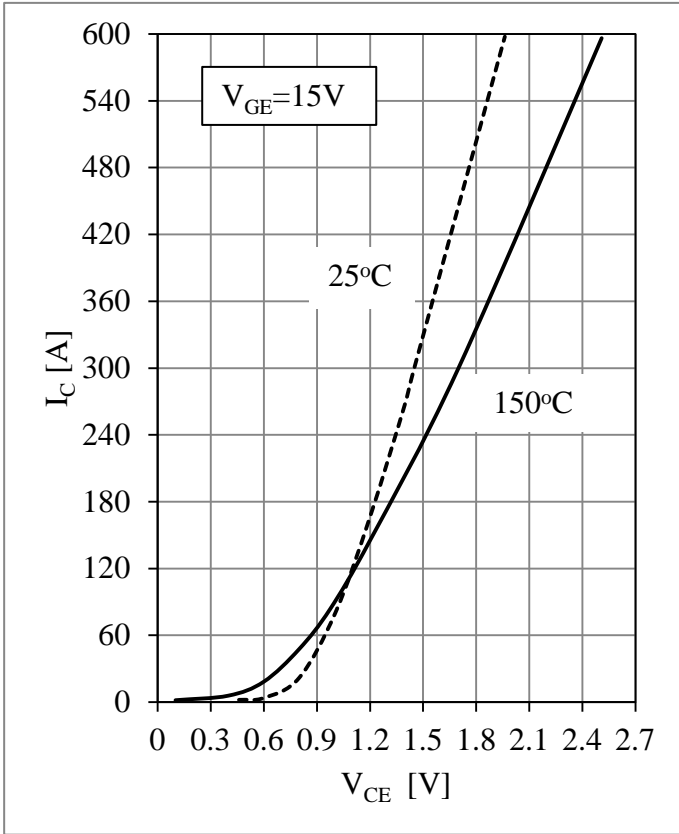

Fig 1. IGBT Output Characteristics

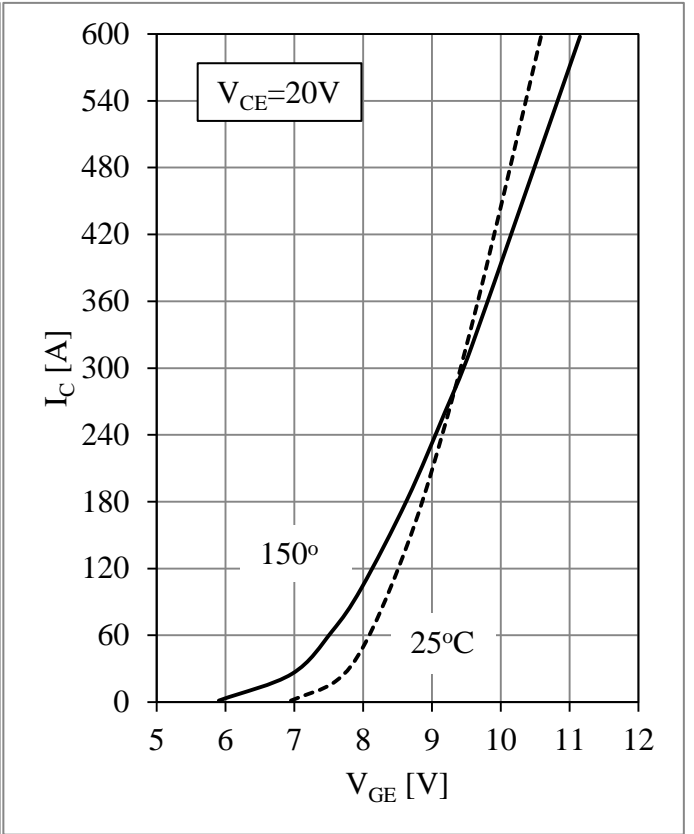

Fig 2. IGBT Transfer Characteristics

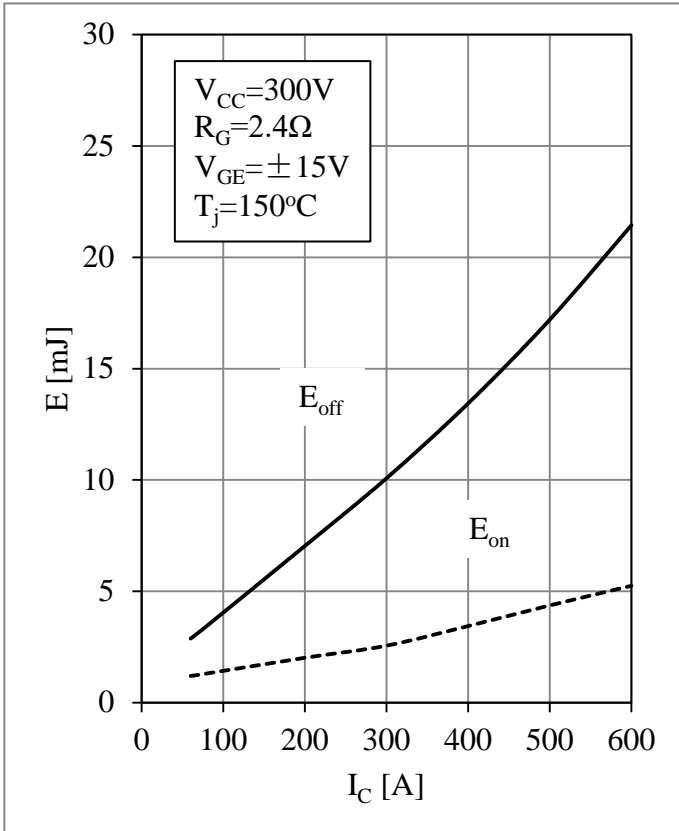

Fig 3. IGBT Switching Loss vs.  $I_c$

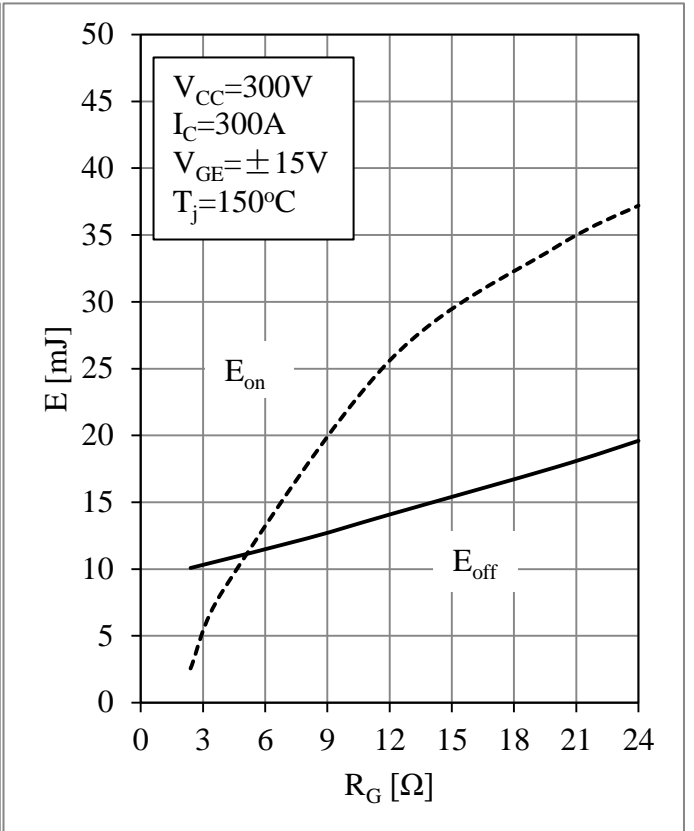

Fig 4. IGBT Switching Loss vs.  $R_G$

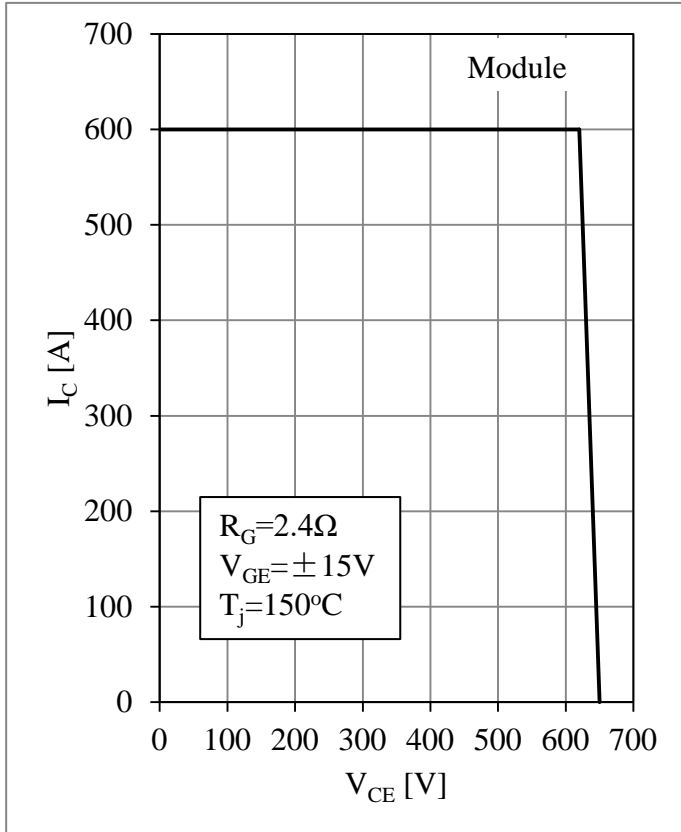

Fig 5. RBSOA

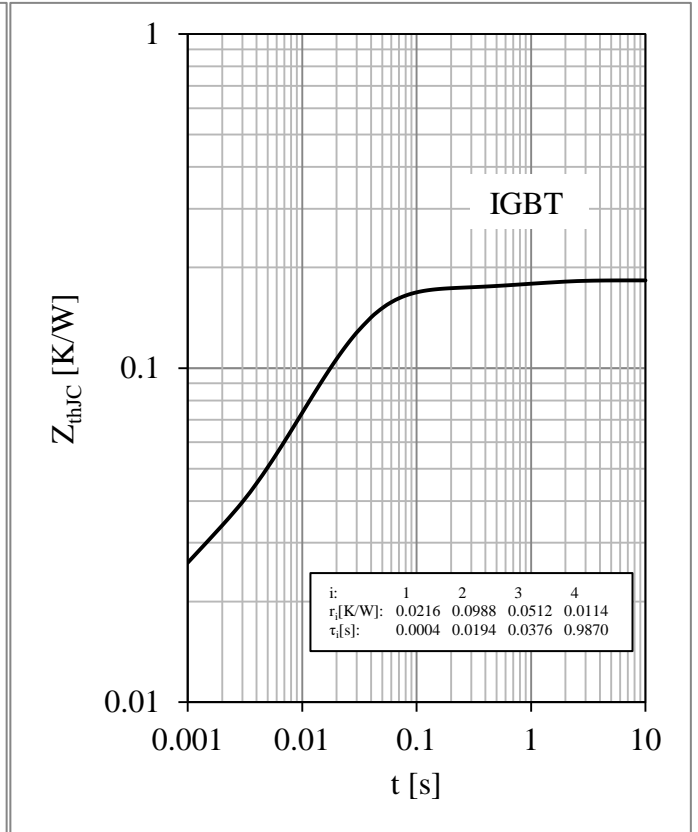

Fig 6. IGBT Transient Thermal Impedance

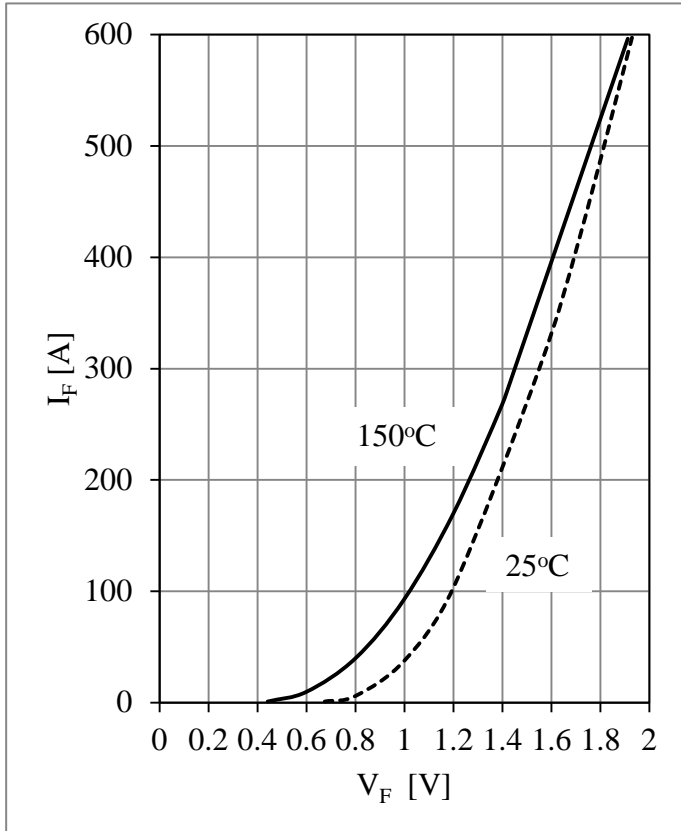

Fig 7. Diode Forward Characteristics

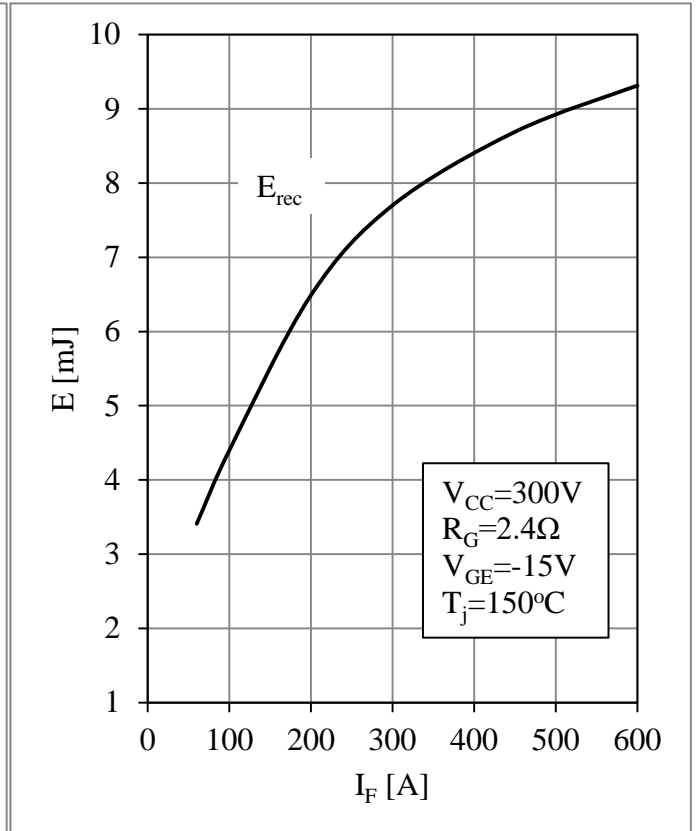

Fig 8. Diode Switching Loss vs.  $I_F$

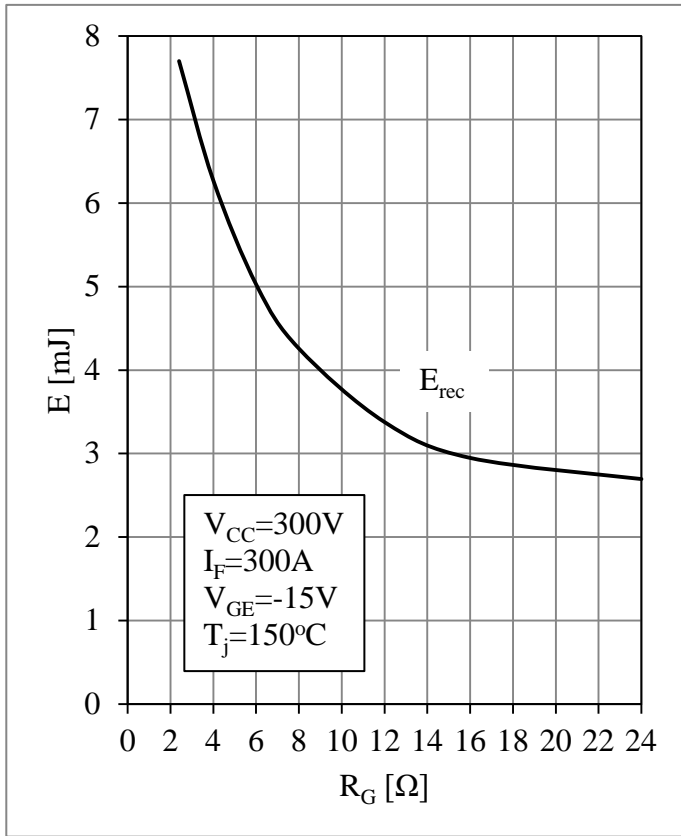

Fig 9. Diode Switching Loss vs.  $R_G$

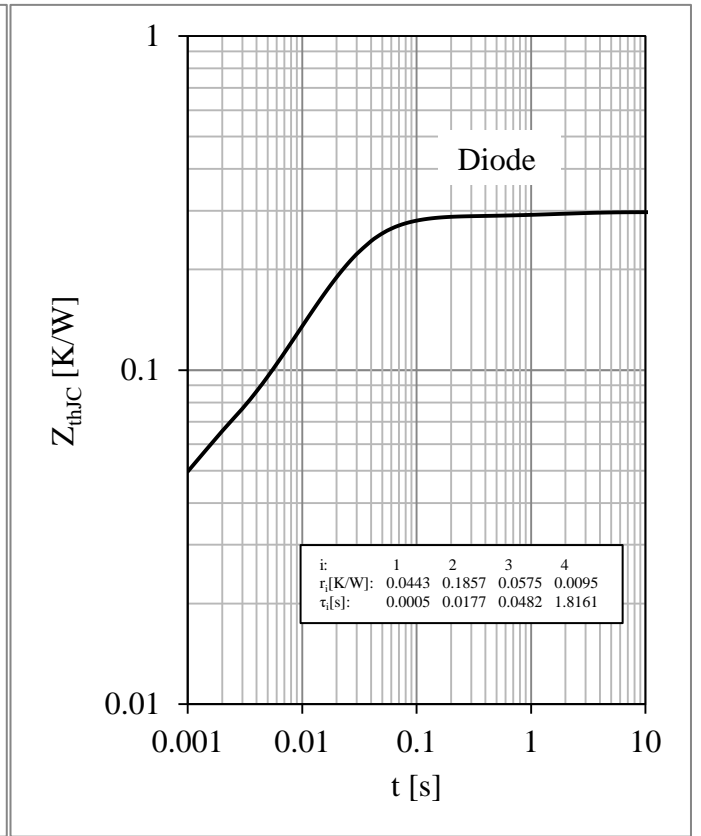
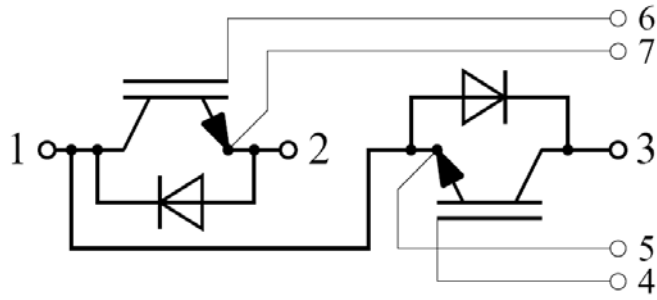

Fig 10. Diode Transient Thermal Impedance

### Circuit Schematic



### Package Dimensions

Dimensions in Millimeters

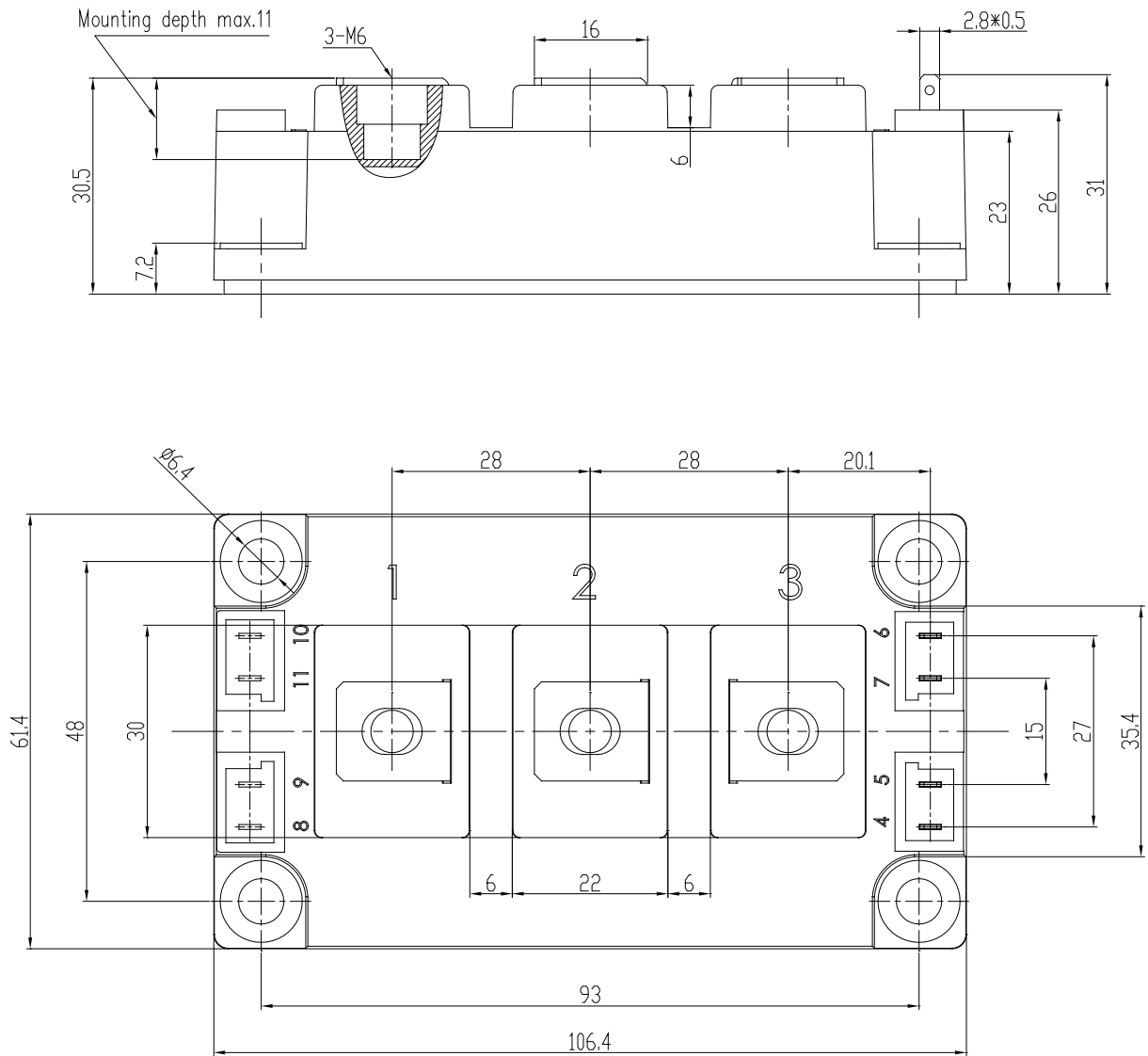



## Terms and Conditions of Usage

The data contained in this product datasheet is exclusively intended for technically trained staff. you and your technical departments will have to evaluate the suitability of the product for the intended application and the completeness of the product data with respect to such application.

This product data sheet is describing the characteristics of this product for which a warranty is granted. Any such warranty is granted exclusively pursuant the terms and conditions of the supply agreement. There will be no guarantee of any kind for the product and its characteristics.

Should you require product information in excess of the data given in this product data sheet or which concerns the specific application of our product, please contact the sales office, which is responsible for you (see [www.powersemi.cc](http://www.powersemi.cc)), For those that are specifically interested we may provide application notes.

Due to technical requirements our product may contain dangerous substances. For information on the types in question please contact the sales office, which is responsible for you.

Should you intend to use the Product in aviation applications, in health or live endangering or life support applications, please notify.

If and to the extent necessary, please forward equivalent notices to your customers.  
Changes of this product data sheet are reserved.