

# STARPOWER

SEMICONDUCTOR

**IGBT**

## GD200CUL170C2S

**1700V/200A chopper in one-package**

### General Description

STARPOWER IGBT Power Module provides ultra low conduction loss as well as short circuit ruggedness. They are designed for the applications such as general inverters and UPS.

### Features

- Low  $V_{CE(sat)}$  SPT+ IGBT technology
- 10 $\mu$ s short circuit capability
- $V_{CE(sat)}$  with positive temperature coefficient
- Maximum junction temperature 175°C
- Low inductance case
- Fast & soft reverse recovery anti-parallel FWD
- Isolated copper baseplate using DBC technology



### Typical Applications

- Inverter for motor drive
- AC and DC servo drive amplifier
- Uninterruptible power supply

### Equivalent Circuit Schematic

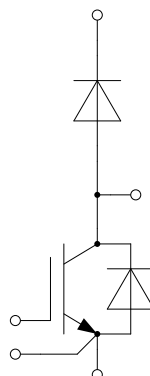

**Absolute Maximum Ratings**  $T_C=25^{\circ}\text{C}$  unless otherwise noted**IGBT**

Symbol	Description	Value	Unit
$V_{CES}$	Collector-Emitter Voltage	1700	V
$V_{GES}$	Gate-Emitter Voltage	$\pm 20$	V
$I_C$	Collector Current @ $T_C=25^{\circ}\text{C}$	305	A
	@ $T_C=100^{\circ}\text{C}$	200	A
$I_{CM}$	Pulsed Collector Current $t_p=1\text{ms}$	400	A
$P_D$	Maximum Power Dissipation @ $T_j=175^{\circ}\text{C}$	1388	W

**Diode**

Symbol	Description	Value	Unit
$V_{RRM}$	Repetitive Peak Reverse Voltage	1700	V
$I_F$	Diode Continuous Forward Current	200	A
$I_{FM}$	Diode Maximum Forward Current $t_p=1\text{ms}$	400	A

**Module**

Symbol	Description	Value	Unit
$T_{jmax}$	Maximum Junction Temperature	175	$^{\circ}\text{C}$
$T_{jop}$	Operating Junction Temperature	-40 to +150	$^{\circ}\text{C}$
$T_{STG}$	Storage Temperature Range	-40 to +125	$^{\circ}\text{C}$
$V_{ISO}$	Isolation Voltage RMS, $f=50\text{Hz}$ , $t=1\text{min}$	4000	V

**IGBT Characteristics**  $T_c=25^\circ\text{C}$  unless otherwise noted

Symbol	Parameter	Test Conditions	Min.	Typ.	Max.	Unit	
$V_{CE(sat)}$	Collector to Emitter Saturation Voltage	$I_C=200\text{A}, V_{GE}=15\text{V}, T_j=25^\circ\text{C}$		2.40	2.85	V	
		$I_C=200\text{A}, V_{GE}=15\text{V}, T_j=125^\circ\text{C}$		2.80			
		$I_C=200\text{A}, V_{GE}=15\text{V}, T_j=150^\circ\text{C}$		2.90			
$V_{GE(th)}$	Gate-Emitter Threshold Voltage	$I_C=8.0\text{mA}, V_{CE}=V_{GE}, T_j=25^\circ\text{C}$	5.4	6.2	7.4	V	
$I_{CES}$	Collector Cut-Off Current	$V_{CE}=V_{CES}, V_{GE}=0\text{V}, T_j=25^\circ\text{C}$			1.0	mA	
$I_{GES}$	Gate-Emitter Leakage Current	$V_{GE}=V_{GES}, V_{CE}=0\text{V}, T_j=25^\circ\text{C}$			400	nA	
$R_{Gint}$	Internal Gate Resistance			2.9		$\Omega$	
$C_{ies}$	Input Capacitance	$V_{CE}=25\text{V}, f=1\text{MHz}, V_{GE}=0\text{V}$		13.5		nF	
$C_{res}$	Reverse Transfer Capacitance			0.46		nF	
$Q_G$	Gate Charge	$V_{GE}=-15\dots+15\text{V}$		1.5		$\mu\text{C}$	
$t_{d(on)}$	Turn-On Delay Time	$V_{CC}=900\text{V}, I_C=200\text{A}, R_G=6.8\Omega, V_{GE}=\pm 15\text{V}, T_j=25^\circ\text{C}$		402		ns	
$t_r$	Rise Time			129		ns	
$t_{d(off)}$	Turn-Off Delay Time			371		ns	
$t_f$	Fall Time			383		ns	
$E_{on}$	Turn-On Switching Loss			64.9		mJ	
$E_{off}$	Turn-Off Switching Loss			36.3		mJ	
$t_{d(on)}$	Turn-On Delay Time		$V_{CC}=900\text{V}, I_C=200\text{A}, R_G=6.8\Omega, V_{GE}=\pm 15\text{V}, T_j=125^\circ\text{C}$		393		ns
$t_r$	Rise Time				130		ns
$t_{d(off)}$	Turn-Off Delay Time			367		ns	
$t_f$	Fall Time			417		ns	
$E_{on}$	Turn-On Switching Loss			87.7		mJ	
$E_{off}$	Turn-Off Switching Loss			64.4		mJ	
$t_{d(on)}$	Turn-On Delay Time	$V_{CC}=900\text{V}, I_C=200\text{A}, R_G=6.8\Omega, V_{GE}=\pm 15\text{V}, T_j=150^\circ\text{C}$			387		ns
$t_r$	Rise Time				131		ns
$t_{d(off)}$	Turn-Off Delay Time			369		ns	
$t_f$	Fall Time			434		ns	
$E_{on}$	Turn-On Switching Loss			96.5		mJ	
$E_{off}$	Turn-Off Switching Loss			70.8		mJ	
$I_{SC}$	SC Data		$t_p \leq 10\mu\text{s}, V_{GE}=15\text{V}, T_j=150^\circ\text{C}, V_{CC}=1000\text{V}, V_{CEM} \leq 1700\text{V}$		620		A

**Diode Characteristics**  $T_C=25^{\circ}\text{C}$  unless otherwise noted

Symbol	Parameter	Test Conditions	Min.	Typ.	Max.	Unit
$V_F$	Diode Forward Voltage	$I_F=200\text{A}, V_{GE}=0\text{V}, T_j=25^{\circ}\text{C}$		1.80	2.25	V
		$I_F=200\text{A}, V_{GE}=0\text{V}, T_j=125^{\circ}\text{C}$		1.95		
		$I_F=200\text{A}, V_{GE}=0\text{V}, T_j=150^{\circ}\text{C}$		1.90		
$Q_r$	Recovered Charge	$V_R=900\text{V}, I_F=200\text{A},$ $-di/dt=1450\text{A}/\mu\text{s}, V_{GE}=-15\text{V}$ $T_j=25^{\circ}\text{C}$		50.6		$\mu\text{C}$
$I_{RM}$	Peak Reverse Recovery Current			143		A
$E_{rec}$	Reverse Recovery Energy			28.5		mJ
$Q_r$	Recovered Charge	$V_R=900\text{V}, I_F=200\text{A},$ $-di/dt=1450\text{A}/\mu\text{s}, V_{GE}=-15\text{V}$ $T_j=125^{\circ}\text{C}$		70.1		$\mu\text{C}$
$I_{RM}$	Peak Reverse Recovery Current			190		A
$E_{rec}$	Reverse Recovery Energy			38.3		mJ
$Q_r$	Recovered Charge	$V_R=900\text{V}, I_F=200\text{A},$ $-di/dt=1450\text{A}/\mu\text{s}, V_{GE}=-15\text{V}$ $T_j=150^{\circ}\text{C}$		81.3		$\mu\text{C}$
$I_{RM}$	Peak Reverse Recovery Current			219		A
$E_{rec}$	Reverse Recovery Energy			42.1		mJ

**Module Characteristics**  $T_C=25^{\circ}\text{C}$  unless otherwise noted

Symbol	Parameter	Min.	Typ.	Max.	Unit
$L_{CE}$	Stray Inductance			20	nH
$R_{CC'+EE'}$	Module Lead Resistance, Terminal to Chip		0.35		m $\Omega$
$R_{thJC}$	Junction-to-Case (per IGBT)			0.108	K/W
	Junction-to-Case (per Diode)			0.178	
$R_{thCH}$	Case-to-Heatsink (per IGBT)		0.077		K/W
	Case-to-Heatsink (per Diode)		0.128		
	Case-to-Heatsink (per Module)		0.035		
M	Terminal Connection Torque, Screw M6	2.5		5.0	N.m
	Mounting Torque, Screw M6	3.0		5.0	
G	Weight of Module		300		g

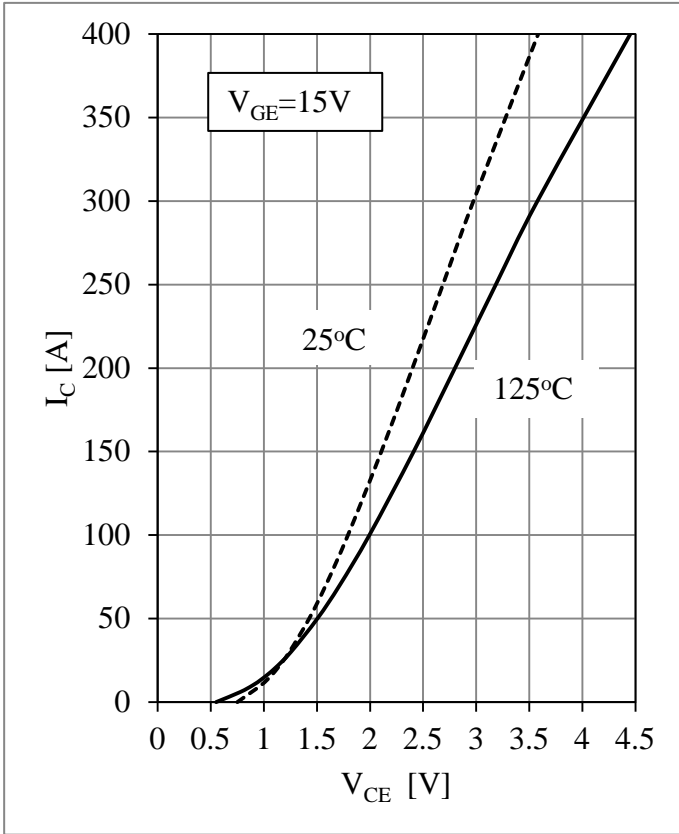

Fig 1. IGBT Output Characteristics

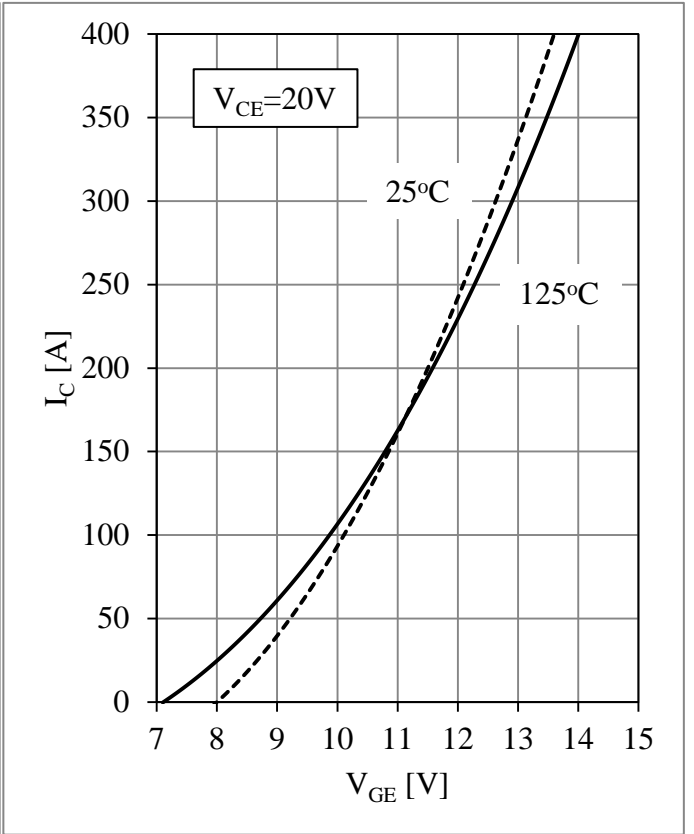

Fig 2. IGBT Transfer Characteristics

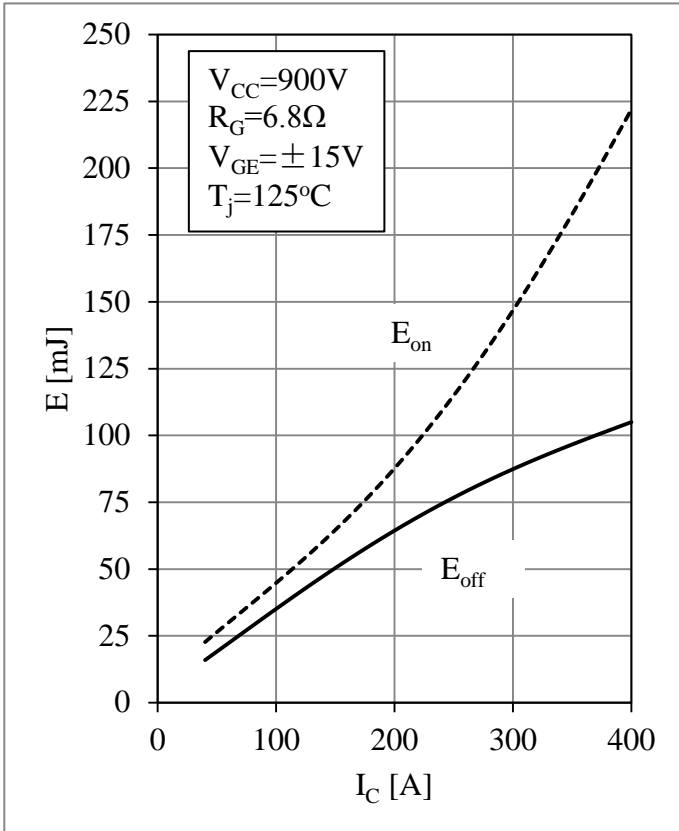

Fig 3. IGBT Switching Loss vs.  $I_C$

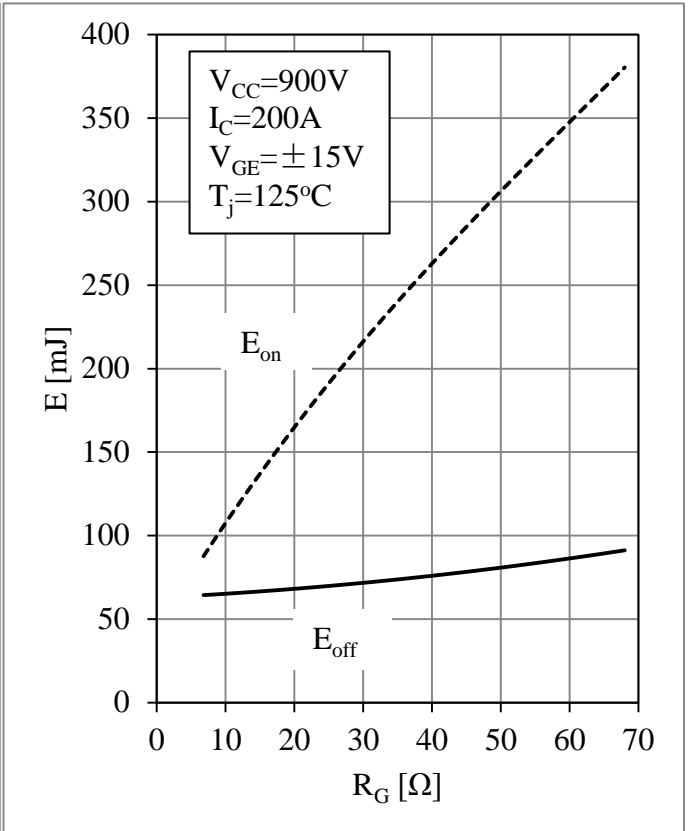

Fig 4. IGBT Switching Loss vs.  $R_G$

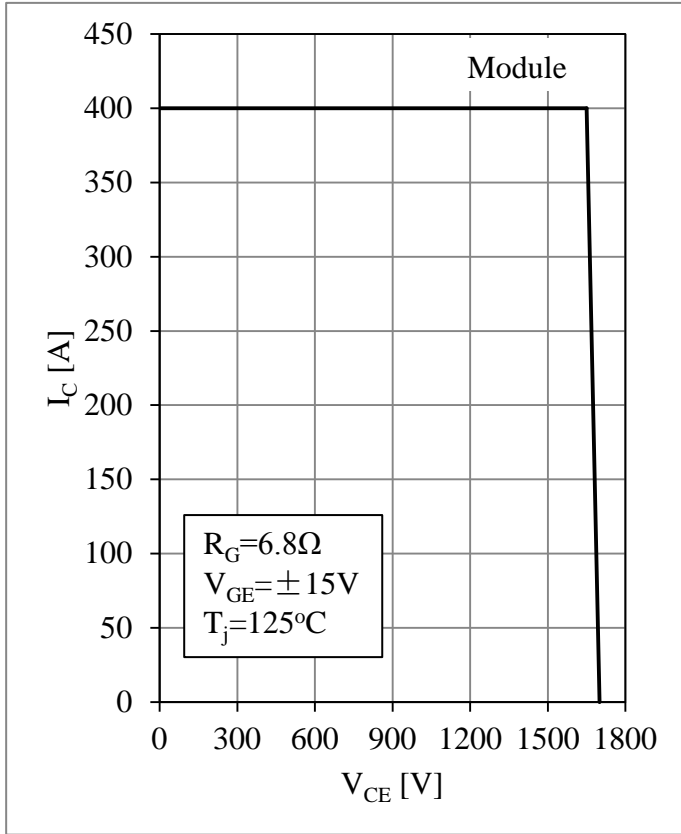

Fig 5. RBSOA

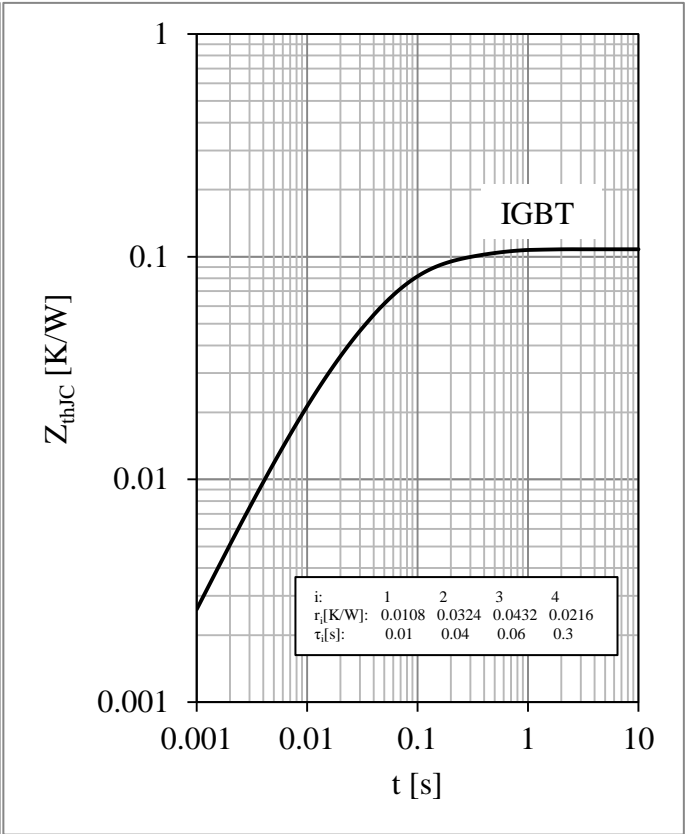

Fig 6. IGBT Transient Thermal Impedance

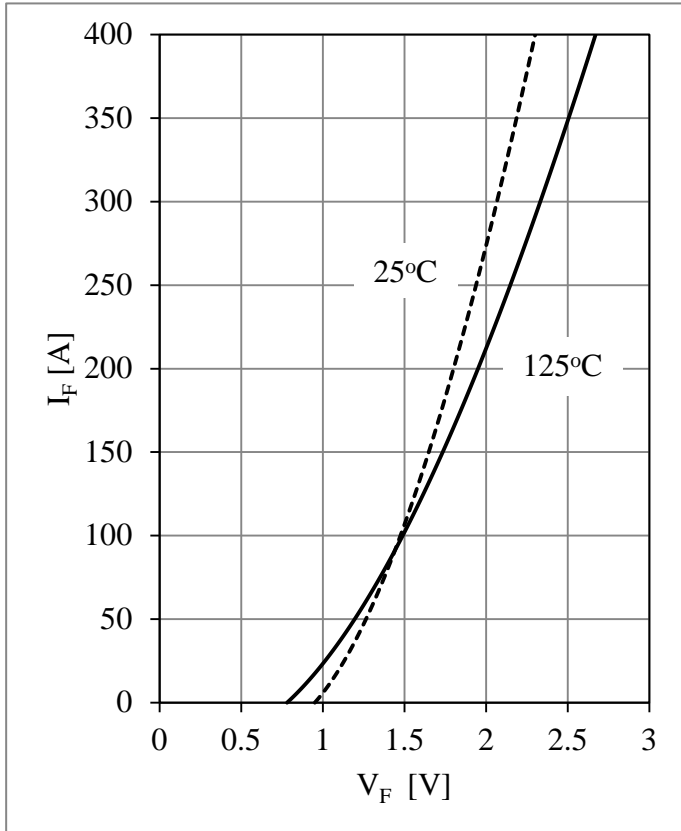

Fig 7. Diode Forward Characteristics

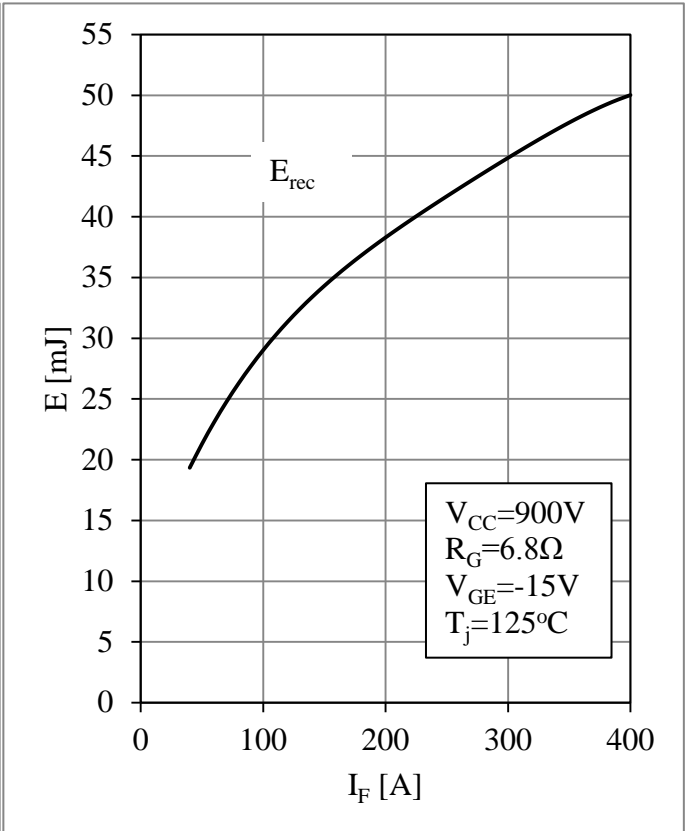

Fig 8. Diode Switching Loss vs.  $I_F$

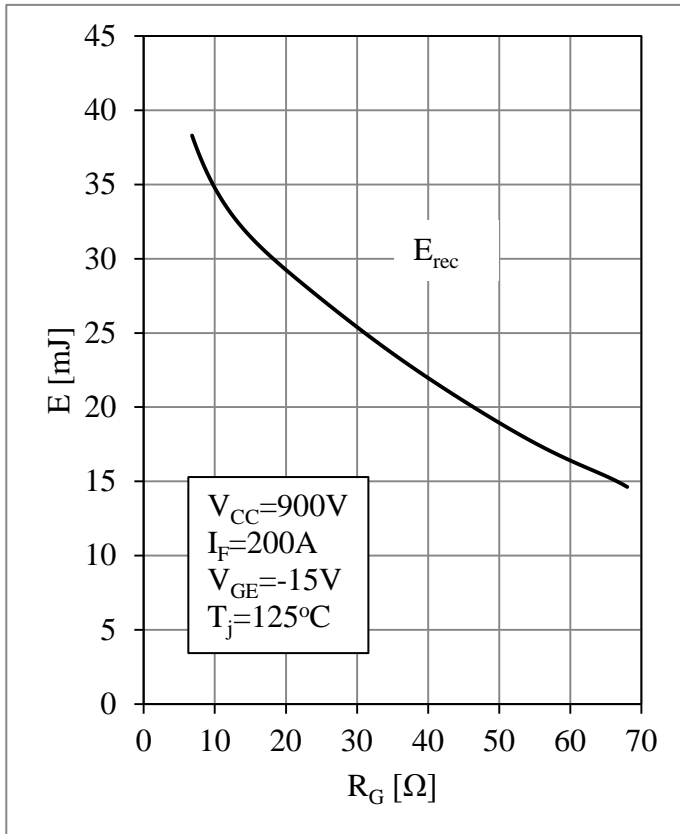

Fig 9. Diode Switching Loss vs.  $R_G$

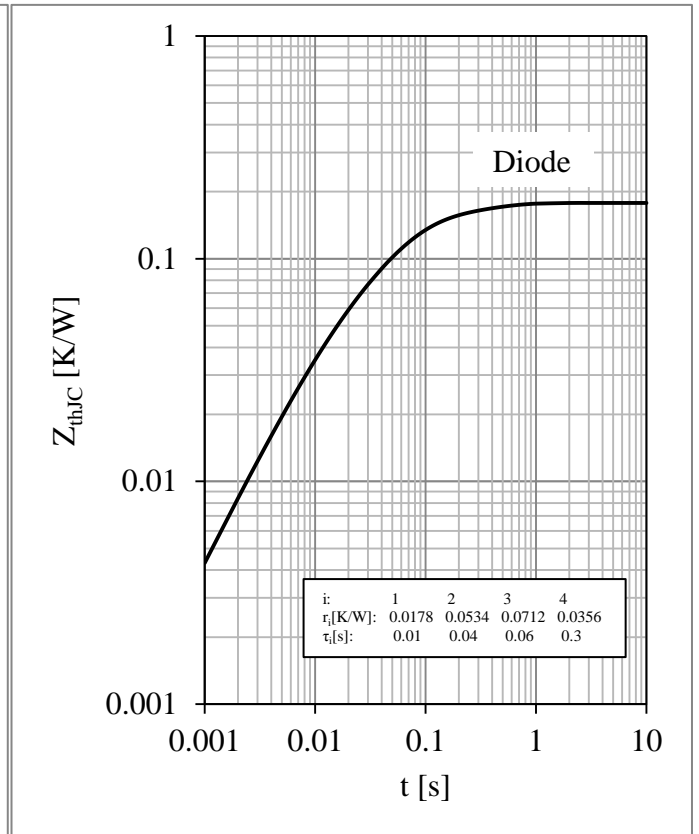
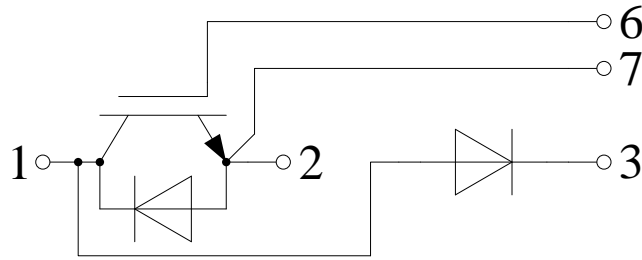

Fig 10. Diode Transient Thermal Impedance

### Circuit Schematic



### Package Dimensions

Dimensions in Millimeters

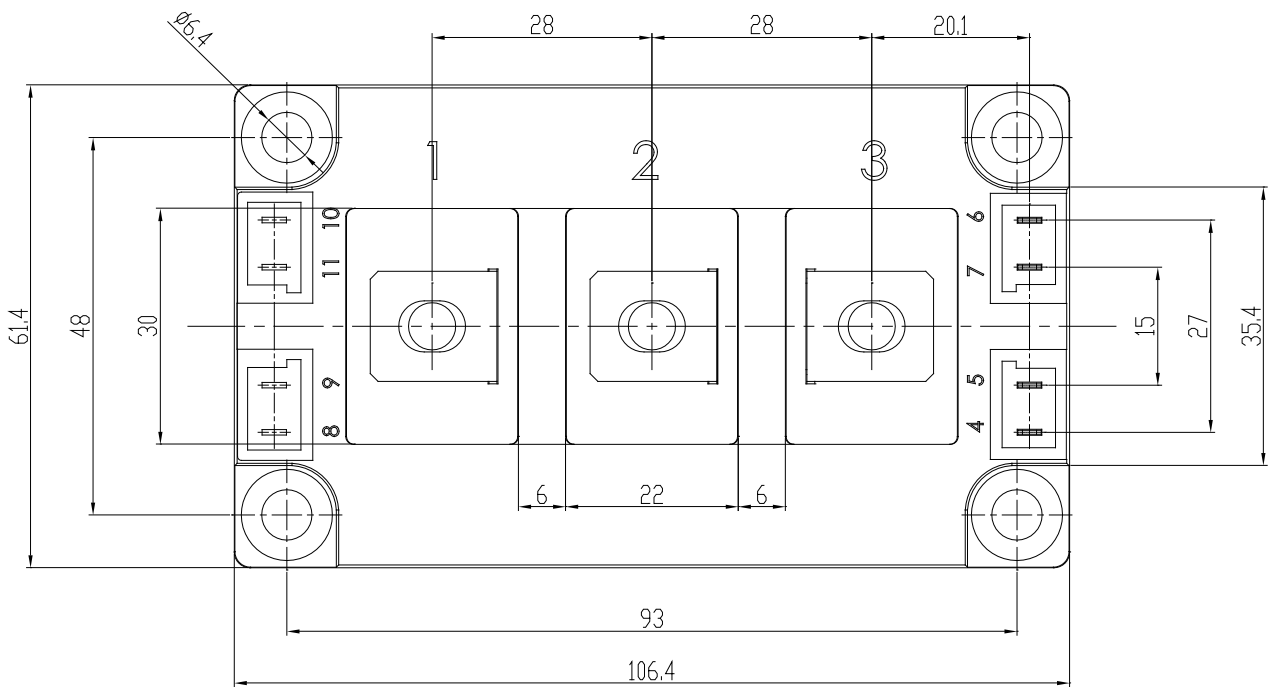
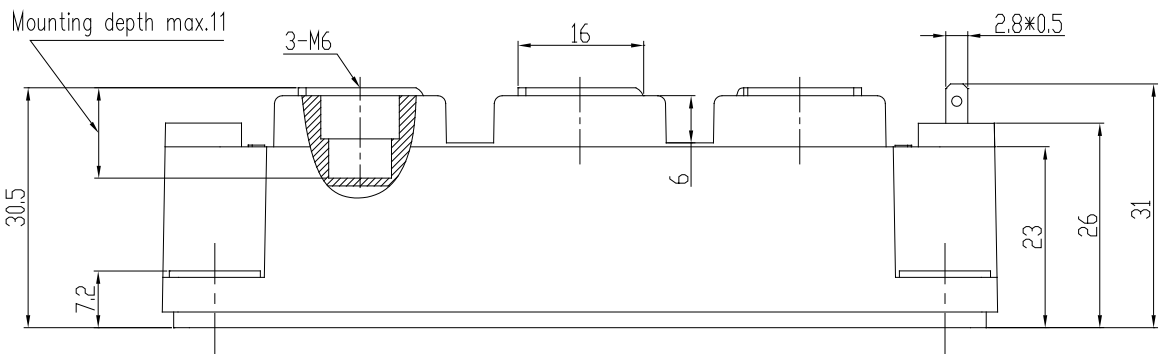



## Terms and Conditions of Usage

The data contained in this product datasheet is exclusively intended for technically trained staff. you and your technical departments will have to evaluate the suitability of the product for the intended application and the completeness of the product data with respect to such application.

This product data sheet is describing the characteristics of this product for which a warranty is granted. Any such warranty is granted exclusively pursuant the terms and conditions of the supply agreement. There will be no guarantee of any kind for the product and its characteristics.

Should you require product information in excess of the data given in this product data sheet or which concerns the specific application of our product, please contact the sales office, which is responsible for you (see [www.powersemi.cc](http://www.powersemi.cc)), For those that are specifically interested we may provide application notes.

Due to technical requirements our product may contain dangerous substances. For information on the types in question please contact the sales office, which is responsible for you.

Should you intend to use the Product in aviation applications, in health or live endangering or life support applications, please notify.

If and to the extent necessary, please forward equivalent notices to your customers.  
Changes of this product data sheet are reserved.